

DART

CONTROLS

Instruction Manual

For Digital Plus Series Options

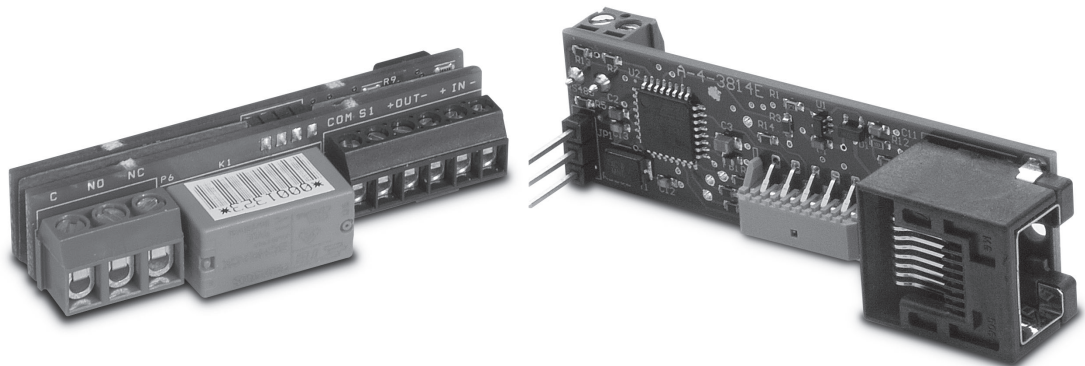

**5000 W. 106th Street
Zionsville, Indiana 46077**

**Phone (317) 873-5211
Fax (317) 873-1105
www.dartcontrols.com**

TABLE OF CONTENTS

Warranty	1
Warning	1
How to Change an Item's Value	2
OPT420 Installation & Diagrams	2
Installing the OPT420 in Slot 100 or Slot 200 of the Host Drive.....	2
OPT420 P3 & P6 Terminal Block Hook-Up Diagrams.....	3
OPT 420 Hook-Up Diagram (typical)	3
OPT420 P3 Terminal Block Descriptions.....	3
OPT420 P6 Terminal Block Descriptions.....	4
OPT420 Software Parameters (Items)	4
OPT420 Software Item (Parameter) Descriptions	5
OPT420 Real-Time Process Variables (Read Only), Items 70 - 74	6
OPT51 Installation & Diagrams	7
Installing the OPT51 in Slot 500 of the Host Drive.....	7
OPT 51 Installation	7
OPT51 P3 Terminal Block Hook-Up Diagram	8
OPT51 P3 Terminal Block Description.....	8
Using the Analog Input	8
Overview.....	8
Types of Signal Sources.....	8
Routing of Analog Signals	9
Field Customizing.....	10
Wiring Connection.....	11
Using the Frequency Generator Output*	12
User-Assignable Output	13
Communications and Networking	13
Commonly Used Software.....	13
Hardware - Jumper Selection	14
RS232 and RS422/485 Connections to the RJ45 Modular Jack	14
Software - Data Format	16
Format for Messages	16
Direct Commands from a Computer/PLC.....	18
SP Set Target Speed (or Time in seconds)	18
SV Set Variable.....	18
RV Read Variable.....	19
TS Get Target Speed.....	19
AS Get Actual Speed	19
AL Get Alarm State.....	19
OPT51 Software Parameters (Items)	20
OPT51 Software Item (Parameter) Descriptions	21
Specifications	37
Electrical.....	37

NOTE: This manual revision is applicable to MD plus software Version 14 and up. See page 15 of MD Plus Manual for information on determining the software version numbers of a particular unit.

Warranty

Dart Controls, Inc. (DCI) warrants its products to be free from defects in material and workmanship. The exclusive remedy for this warranty is DCI factory replacement of any part or parts of such product which shall within 12 months after delivery to the purchaser be returned to DCI factory with all transportation charges prepaid and which DCI determines to its satisfaction to be defective. This warranty shall not extend to defects in assembly by other than DCI or to any article which has been repaired or altered by other than DCI or to any article which DCI determines has been subjected to improper use. DCI assumes no responsibility for the design characteristics of any unit or its operation in any circuit or assembly. This warranty is in lieu of all other warranties, express or implied; all other liabilities or obligations on the part of DCI, including consequential damages, are hereby expressly excluded.

NOTE: Carefully check the control for shipping damage. Report any damage to the carrier immediately. Do not attempt to operate the drive if visible damage is evident to either the circuit or to the electronic components.

All information contained in this manual is intended to be correct, however information and data in this manual are subject to change without notice. DCI makes no warranty of any kind with regard to this information or data. Further, DCI is not responsible for any omissions or errors or consequential damage caused by the user of the product. DCI reserves the right to make manufacturing changes which may not be included in this manual.

Warning

Improper installation or operation of this control may cause injury to personnel or control failure. The control must be installed in accordance with local, state, and national safety codes. Make certain that the power supply is disconnected before attempting to service or remove any components!!! If the power disconnect point is out of sight, lock it in disconnected position and tag to prevent unexpected application of power. Only a qualified electrician or service personnel should perform any electrical troubleshooting or maintenance. At no time should circuit continuity be checked by shorting terminals with a screwdriver or other metal device.

How to Change an Item's Value

1. Hold down the Enter button until Item-Selection Mode is entered. The 'Item' Annunciator will light
2. Using the Up and Down buttons, select the desired Item number to view or edit
3. Press the Enter button to change the value of the Item. The 'Valu' Annunciator will light
4. Using the Up and Down buttons, change the Item's value as desired
5. Press the Enter button to save the changes (Returns to Item-Selection Mode)
6. Select Item Zero ("0") and press the Enter button to return to Running Mode

Note: For long story see control manual for explanation.

OPT420

The OPT420 is a Dart ModularBus "option card" featuring an Optically-Isolated 4-20mA Current Loop Input and an Optically-Isolated 4-20mA Current Loop Output. Both the input and output are Optically-Isolated from the Host Drive, circuit common, earth ground, and from each other. In addition, a non-isolated SPST switch input is provided. In the typical application with an MD40/50-420, that switch is used to determine where the Host Drive gets its "Target Speed" setting. Additionally, the MD40P-420, MD50P-420 and MD50E-420 have an "Auto/Manual" LED Annunciator which displays whether the source of the Target Setting comes from the 4-20mA input ("Auto") or from the "front panel" Target setting ("Manual"). Both the input and output 4-20mA loops require customer supplied 9-36Vdc loop excitation power supplies.

In "Manual" mode, the Host Drive uses its normal Front Panel display and Up/Down buttons to set the Target Speed (or Time). However, in "Auto" mode, the Host Drive follows the OPT420's 4-20mA Current Loop signal. In either mode, the OPT420's Current Loop Output provides a real-time updating 4-20mA signal that represents the Host Drive motor's Actual (Tach) Speed. This is primarily used by a SCADA system to provide "feedback" that the SCADA's speed setting was received and acted upon by the Host Drive.

Installing the OPT420 in Slot 200 of the Host Drive

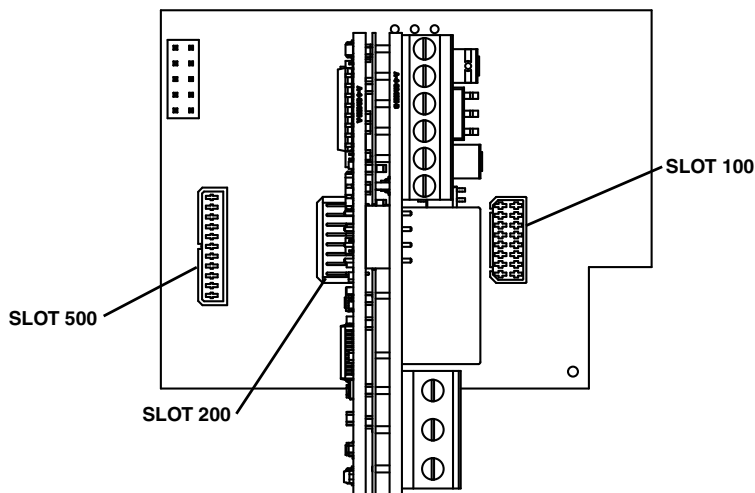

IMPORTANT: THE OPT420 CAN ONLY BE INSTALLED IN MODULARBUS SLOT 200.

Also, the OPT420 comes with Default Values that should allow a simple checkout procedure to verify that everything is hooked-up correctly and functioning. See the OPT420 Item (Parameter) Table for further details.

When the OPT420 is first installed, the following message will appear on the display.

"Configuration Change--Card in slot is different than stored configuration--Up button to store factory defaults...dn button to ignore card."

If the up button is pushed, the factory settings will be installed and the card will be initialized. If the down button is pushed, the factory settings will NOT be installed and the card will NOT be initialized.

OPT420 P3 & P6 Terminal Block Hook-Up Diagrams

IMPORTANT: THE OPT420 DOES NOT SUPPLY LOOP "EXCITATION VOLTAGE". If the flowmeter, SCADA system, etc. does not have a Loop Excitation supply, an external voltage must be provided from +9 to +36VDC capable of at least 50mA for each of the two 4-20mA Current Loops (Input and Output), as shown in the diagram below. Additionally, if the Input and Output must be isolated from each other, two excitation supplies may be needed.

OPT 420 Hook-Up Diagram (typical)

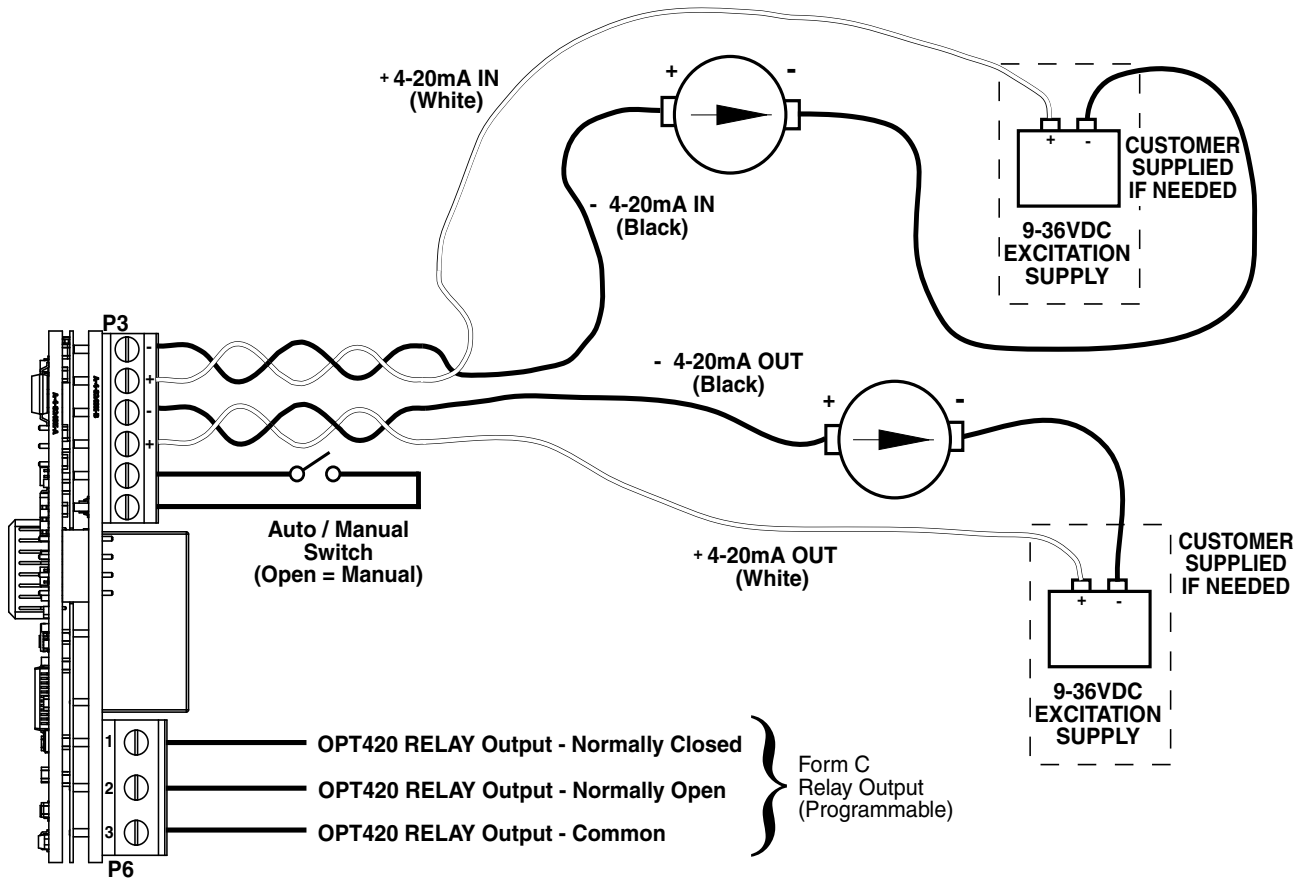

OPT420 P3 Terminal Block Descriptions

- P3-1 (- 4-20mA Input) – Connect this terminal to the next 4-20mA device in the loop, or, if the OPT420 is the last device in the current loop, then connect this terminal to the - (negative) side of the current loop.
- P3-2 (+ 4-20mA Input) – Connect this terminal to the previous 4-20mA device in the loop, or, if the OPT420 is the first device in the current loop, then connect this terminal to the + (positive) side of the current loop.
- P3-3 (- 4-20mA Output) – Connect this terminal to the next 4-20mA device in the loop, or, if the OPT420 is the last device in the current loop, then connect this terminal to the - (negative) side of the current loop.
- P3-4 (+ 4-20mA Output) – Connect this terminal to the previous 4-20mA device in the loop, or, if the OPT420 is the first device in the current loop, then connect this terminal to the + (positive) side of the current loop.
- P3-5 (S1 Input) – Connect this terminal to one side of a SPST switch to control Auto/Manual Operation. If switch is OPEN (or unconnected), MD40/50-420 Target Speed will come from its Target Speed setting (as usual), if the switch is CLOSED, MD40/50-420 Target Speed will follow the OPT420 4-20mA Current Loop Input. This signal is internally "pulled-up" via a 15K ohm resistor.
- P3-6 (COM) – This is the common point for the control logic. Normally, the other side of the SPST Auto/Manual switch would be connected to this terminal.

Note: P3-1, 2, 3, & 4 are isolated inputs.

OPT420 P6 Terminal Block Descriptions

P6-1 (NC) – This is the normally-closed contact of the user-assignable OPT420 Alarm 2 relay.

P6-2 (NO) – This is the normally-open contact of the user-assignable OPT420 Alarm 2 relay.

P6-3 (C) – This is the common contact of the user-assignable OPT420 Alarm 2 relay.

OPT420 Software Parameters (Items)

Note: Add the ModularBus “Slot” Number (100, 200, 500) X 10 to the Item number below to determine the actual Item Number in the Host Drive’s Item-Numbering scheme. For example, to set Item 41 of an OPT420 in ModularBus Slot 200, you would select Item 2041 (200 X 10 + 41).

Item	Description	Value Range	Units	Factory Default	User Setting
Read-Only Identification Items					
1	Model Number	420 = OPT420	—	420	n/a
2	Software Version	1 – 9999	—	—	n/a
3	Hardware Version	1 – 9999	—	—	n/a
4	Device Type	100 = Type 1 ModularBus Card	—	100	n/a
5	Minimum Supported Framework Version	1 – 9999	—	—	n/a
6	Maximum Supported Protocol Version	1 – 9999	—	—	n/a
7	Serial Number (Major)	0-9999	—	n/a	n/a
8	Serial Number (Minor)	0-9999	—	n/a	n/a
4-20mA Input Scaling Items					
20	OPT420’s Target Speed to Drive @ 4mA Input Current	0 – 9999 (Limited by Drive’s Display Minimum Setting)	Drive’s Eng. Units	0	
21	OPT420’s Target Speed to Drive @ 20mA Input Current	0 – 9999 (Limited by Drive’s Display Maximum Setting)	Drive’s Eng. Units	2400	
22	4mA Input Trim	-600 – +600 ¹	—	0	
23	20mA Input Trim	-600 – +600 ¹	—	0	
4-20mA Output Scaling Items					
40	Actual (S1 tach) Speed from Drive needed to Produce 4mA Output Current from OPT420	0 – 9999	Drive’s Eng. Units	0	
41	Actual (S1 tach) Speed from Drive needed to Produce 20mA Output Current from OPT420	0 – 9999	Drive’s Eng. Units	2400	
42	4mA Output Trim	-600 – +600 ¹	—	0	
43	20mA Output Trim	-600 – +600 ¹	—	0	
Read-Only Real-time Process Variables					
70	Input Current to OPT420	0 – 4095	ADC Steps	n/a	n/a
71	Target Speed to Drive from OPT420	0 – 9999	Drive’s Eng. Units	n/a	n/a
72	Output Current to Drive from OPT420	0 – 4095	DAC Steps	n/a	n/a
73	OPT420 Condition Flags (not yet implemented)	0 = No Active “Flags” 1 – 9999 = Flags Activated	BCD	0	n/a
74	OPT420 Auto/Manual Switch State	0 = Manual Mode 1 = Auto Mode	—	0	n/a

¹ Host Drive’s Display will Flash to indicate Negative Values

OPT420 Software Item (Parameter) Descriptions

Item 1 – Model Number (Read Only)

This number represents the base model number for the product. The model code for the OPT420 ModularBus card is, logically enough, 420. In this manual, where appropriate, the “Drive” in which this OPT420 card is installed is called, generically, the “Host Drive”.

Item 2 – Software Version (Read Only)

The software version is a code which identifies the software “build number” of the unit.

Item 3 – Hardware Version (Read Only)

The hardware version is a code which identifies the hardware used to build the unit.

Item 4 – ModularBus Card Device Type (Read Only)

This value is primarily used to determine whether the particular ModularBus card has on-board non-volatile storage for its Item settings. The OPT420 is a “Type 1” ModularBus card (value = 100), which does not have its own non-volatile storage. It depends on the Host Drive to store its Item settings. This means that if an OPT420 must be replaced in a Host Drive, the “new” OPT420 does not need to be configured. It will simply “inherit” the “old” OPT420’s Item settings, provided it is placed in the same ModularBus Slot.

Item 5 – Minimum Supported Framework Version (Read Only)

The lowest software “framework” version that is compatible with this ModularBus card.

Item 6 – ModularBus Protocol Version (Read Only)

The ModularBus protocol version is a code which identifies the *highest* (most-recent) version of the ModularBus protocol with which this ModularBus card is compatible.

Item 7 & 8 – Serial Number, Major & Minor (Read Only)

These Items are reserved for future use as an electronic serial number and are unique to each manufactured unit.

Item 20 – OPT420’s Target Speed to Host Drive @ 4mA of Input Current

This is the Target Speed setting that the OPT420 makes available to its Host Drive when there is 4mA of current flowing through the OPT420’s Input Loop terminals. The setting is in the Host Drive’s “Engineering Units”, just as if the Target Speed was being entered on the Host Drive itself. This setting is limited by the Host Drive’s Minimum Display setting.

Item 21 – OPT420’s Target Speed to Host Drive @ 20mA of Input Current

This is the Target Speed setting that the OPT420 makes available to its Host Drive when there is 20mA of current flowing through the OPT420’s Input Loop terminals. The setting is in the Host Drive’s “Engineering Units”, just as if the Target Speed was being entered on the Host Drive itself. This setting is limited by the Host Drive’s Maximum Display setting. This setting should also be greater than the setting for Item 20, above.

Item 22 – 4mA Input Current Trim

Used to compensate for minor inaccuracies in the overall system that is connected to the OPT420’s Input Loop terminals. This “trim”, which has a range that goes both positive and negative, affects the 4mA endpoint of the OPT420’s input range. To return to the factory-calibrated 4mA endpoint, set this Item to a value of zero.

Item 23 – 20mA Input Current Trim

Used to compensate for minor inaccuracies in the overall system that is connected to the OPT420’s Input Loop terminals. This “trim”, which has a range that goes both positive and negative, affects the 20mA endpoint of the OPT420’s input range. To return to the factory-calibrated 20mA endpoint, set this Item to a value of zero.

Item 40 – Host Drive’s Actual Speed (Tach) Value to Produce 4mA Output from OPT420

This is the Actual Speed (tach) value that the OPT420 translates into 4mA of current flow through the OPT420’s Output Loop terminals. The setting is in the Host Drive’s “Engineering Units”, just as if the Tach Display was being viewed on the Host Drive itself.

Item 41 – Host Drive’s Actual Speed (Tach) Value to Produce 20mA Output from OPT420

This is the Actual Speed (tach) value that the OPT420 translates into 20mA of current flow through the OPT420’s Output Loop terminals. The setting is in the Host Drive’s “Engineering Units”, just as if the Tach Display was being viewed on the Host Drive itself.

Item 42 – 4mA Output Current Trim

Used to compensate for minor inaccuracies in the overall system that is connected to the OPT420’s Output Loop terminals. This “trim”, which has a range that goes both positive and negative, affects the 4mA endpoint of the OPT420’s Output range. To return to the factory-calibrated 4mA endpoint, set this Item to a value of zero.

Item 43 – 20mA Output Current Trim

Used to compensate for minor inaccuracies in the overall system that is connected to the OPT420’s Output Loop terminals. This “trim”, which has a range that goes both positive and negative, affects the 20mA endpoint of the OPT420’s Output range. To return to the factory-calibrated 20mA endpoint, set this Item to a value of zero.

OPT420 Real-Time Process Variables (Read Only), Items 70 - 74

Rather than being a “setting” or a “switch” type Item, Items 70 through 74 on the OPT420 are used to view (only) certain Real-Time “Process” variables going to/from the OPT420. These Items are mainly useful in troubleshooting a particular application, rather than being of general-purpose use.

Item 70 – Input Current to OPT420

This shows the instantaneous input loop current to the OPT420, in raw ADC “steps”. Since the OPT420 uses a 12-bit A/D, the range of this Item can be from 0 to 4095, although it will not get to these extremes in the typical 4-20mA setup. The actual number is of less interest than whether the numbers tend to “follow” a 4-20mA input signal.

Item 71 – Target Speed to Host Drive from OPT420

This shows the instantaneous “Target Speed” that the OPT420 has calculated to make available to the Host Drive, in the Host Drive’s Engineering Units, based on the Input Current flowing through P3 1 & 2 on the OPT420, and the setting of OPT420 Items 20 through 23.

Item 72 – Output Current from OPT420

This shows the instantaneous output loop current from the OPT420, in raw DAC “steps”. Since the OPT420 uses a 12-bit D/A, the range of this Item can be from 0 to 4095, although it will not get to these extremes in the typical 4-20mA setup. The actual number is of less interest than whether the numbers tend to “follow” the Host Drive’s Actual (S1 Pickup) “Tach” speed.

Item 73 – OPT420 Condition "Flags"

Not yet implemented.

Item 74 – OPT420 Auto/Manual (S1) Switch State

This shows the instantaneous state of the Auto/Manual switch input. A value of zero means that the OPT420 will report “Manual” mode to the Host Drive. A value of 1 equals “Auto” mode.

OPT51

The OPT51 is a Dart ModularBus “option card” featuring RS232 or RS485 serial communications plus some additional features. RS232 or RS485 communication is controlled by the position of the jumper on P3 and software Parameter setup. Baud rate is configurable from 300 to 57600. In addition, the OPT51 can output a square wave frequency from 4 pulses per minute to 9999 ppm. An analog input is also available which can be routed to a variety of destinations. Additionally, the OPT51 can drive the “Auto/Manual” LED Annunciator to display whether the source of the Target setting comes from the analog input or from the “Front Panel” Target setting (“Manual”).

In “Manual” mode, the Host Drive uses its normal Front Panel display and Up/Down buttons to set the Target Speed (or Time). The Host Drive doesn't necessarily follow the OPT51 when in “Auto” mode: it is dependent upon parameter 120: Auto/Manual master slot. The Auto/Manual master can be assigned to any slot, and then the card in that slot is in charge of setting the “Auto/Manual” mode for the system. If the OPT51 is the card in the Auto/Manual master slot, only when the OPT51's jumper is set to “Auto” mode is the entire system in “Auto” mode. Then the drive will listen to the card for target speed instruction. The drive doesn't necessarily follow the OPT51's analog input source. That is dependent on the analog input routing option on the serial card. When the card is the Auto/Manual master and is in “Auto” mode, there are a variety of ways the OPT51 can cause the target speed to change. In either mode, the OPT51's serial communications output provides a real time updating data stream that represents the Host Drive motor's Actual (Tach) speed. This is primarily used by a SCADA system to provide “feedback” that the SCADA's speed setting was received and acted upon by the Host Drive.

Installing the OPT51 in Slot 500 of the Host Drive

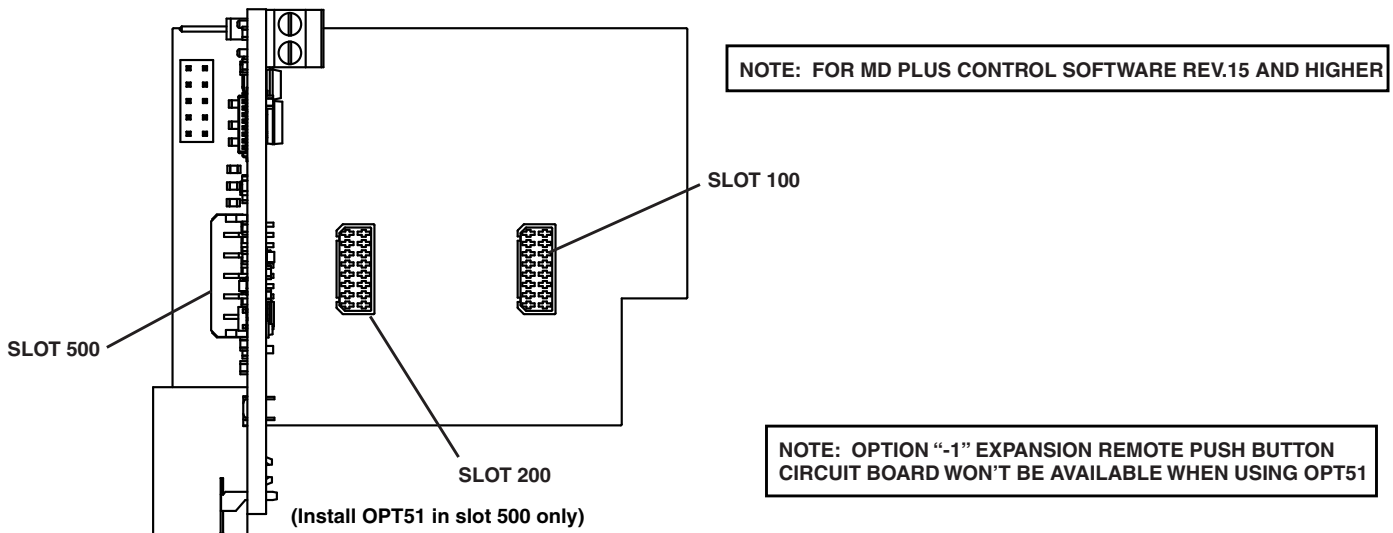

Also, the OPT51 comes with Default Values that should allow a simple checkout procedure to verify that everything is hooked-up correctly and functioning. See the OPT51 Item (Parameter) Table for further details.

When the OPT51 is first installed, the following message will appear on the display:

“Configuration Change -- Card in slot is different than stored configuration -- Up button to store factory defaults....Down button to ignore card.”

If the Up button is pushed, the factory settings will be installed and the card will be initialized. If the Down button is pushed, the factory settings will NOT be installed and the card will NOT be initialized.

OPT51 P3 Terminal Block Hook-Up Diagram

Terminal Block Connection

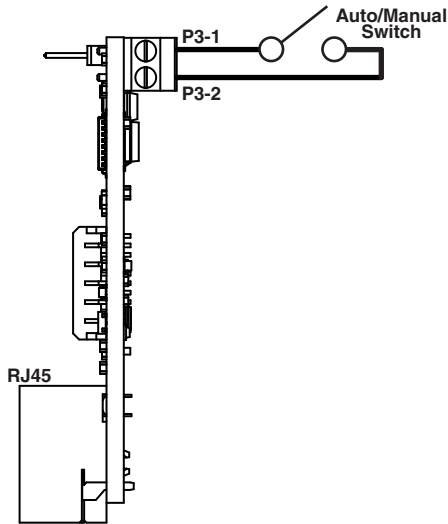

RS232/RS485 Selector

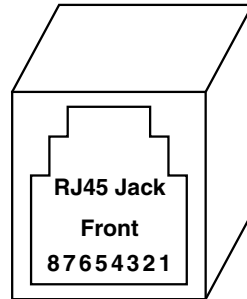
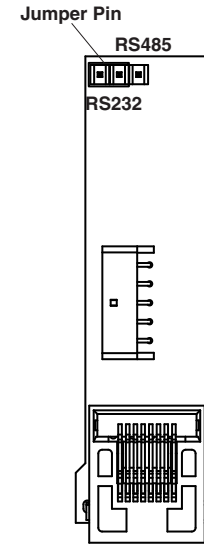

OPT51 P3 Terminal Block Description

P3-1 (COM) – This is common point for the control logic.

P3-2 (SW) – In the open position, the control is in the “Manual” mode. When this terminal is connected to common, the control is in the “Auto” mode.

Using the Analog Input

The OPT51 has a built-in analog to digital converter. This input may be used in lieu of a digital pick-up signal or to control Target speed, current program, or frequency generator output frequency. To use this input with a potentiometer source, connect a pot wiper to Pin 7 of the serial interface port, pot high to the +5V terminal, pot low to the Common terminal. The pot should have a resistance between 500 to 5K ohms. Items 5040-5043 set destination source type and range for the analog input. Setting Items 5042 and 5043 allows the pot source range to be scaled between the min and max set points. A 0 to +5V signal may be used instead of a potentiometer, connect signal to pin 7 of RJ45 and common to pin 6 of the RJ45 (P2-6). Item 5041 should be set for source type. **FOR MORE information on using the analog input, see the following 4 pages.**

Overview

The OPT51 features an analog input. This input, which uses 2 pins on the RJ45 “modular” connector, can be used with a variety of signals. The signal from the analog input can be routed to one of several points, to provide control or “feedback” information to the drive. This application note will cover four major topics:

- What types of signal sources can be used
- How those signals can be used by the OPT51
- Using the Field Customizing for this application
- How to hook up the analog input

Types of Signal Sources

The analog input of the OPT51 has been designed to use basically three types of analog signal sources:

- Potentiometer (500 Ω to 5K Ω only)
- 0 to +5VDC Voltage Source (source impedance < 5K Ω)
- 4 to 20mA Current Source (impedance = 250 Ω .1%, customer supplied)

NOTE: Signals should be positive-going only, and should be within the range of zero to +5 volts DC.

The selection of signal source type tells the drive how to best use the analog information. How this selection is done is covered under the topic “Field Customizing” later in this document. Be sure to select the appropriate type of signal source, or the results will probably be less than optimal. Let’s explore why this is true, by looking at the way the drive treats the various signal source types.

Potentiometer Input:

Because noise is often a problem with potentiometer signals, and to keep the drive from unnecessarily updating information (such as “target speed”) just because the potentiometer jiggled a little bit, selection of the “Potentiometer” type of input forces the drive to behave as follows: First, the analog input must change its value by a small amount before the drive will “pay attention” to it. Once this has happened, the drive will “track” the analog input.

Voltage Source Input:

Selecting this source type will allow rapidly changing analog voltage signals to be “tracked” by the drive. It is primarily intended for use as a “feedback” signal, replacing the conventional “pickup” signal or “leader” signal (for master/follower), although it is not restricted to this use. Values obtained in this way are not stored in “non-volatile” memory, thus they will “go away” when power is shut off to the drive. This should not be a problem for most applications, since the value of the analog input is re-acquired when power is restored. By the way, although this input is actually designed for zero to +5VDC signals, other signal ranges (positive voltage only) such as zero to +10VDC can be accommodated by the use of an external resistive “divider”. Input impedance is approximately equal to 15.4K ohms.

4 to 20mA Current Source Input:

The behavior of this type of analog source is identical to the “Voltage Source” input, with the exception that the value for 4mA is subtracted mathematically from the signal before it is used by the OPT51. The value for 4mA is fixed. Currents of less than 4mA will be treated as the minimum value, and currents greater than 20mA will be treated as the maximum value. Use of this type of signal requires an external resistor (typically 250 Ω). This resistor should be of fairly low tolerance (.1% or better). Using a standard 5% or even 1% resistor can result in major accuracy and drift problems. The wiring of this resistor, and the proper value for it is covered later in this document.

Routing of Analog Signals

Analog signals acquired by the OPT51 can be “routed” to one of several destinations. Except for the Frequency Generator, there is no restriction on what type of source can be routed to what destination, but a particular type of source will generally work best with the destination(s) intended to use that type. Currently, the possible destinations for analog signals are:

- NONE (Analog Input Ignored)
- Target “Speed” Setting
- Percent of Target Setting
- Frequency Generator Rate
- Main “Tach” signal (replaces regular pickup)
- Leader “Tach” signal (replaces regular signal)

The possible types of analog input sources for each destination is shown below:

Destination	Pot	Voltage	Current
Target Speed	Y	Y	Y
% of Target	Y	Y	Y
Freq. Gen.	Y	N	N
Main "Tach"	Y	Y	Y
Leader "Tach"	Y	Y	Y

NOTE: If the analog input is routed to a function that can also be controlled by the front panel buttons or serial communications messages, any of those sources can potentially change the value of that function, depending on who changes it most recently. This will not harm the drive in any way, but should be considered when setting up the system in which the drive is to be used. See the drive manual section "JP1 (Program Enable Jumper)" for details on how to lock-out functions so that they cannot be changed from the front panel.

WARNING:

When the analog input is routed to either the Main "Tach" signal or the Leader "Tach" signal, the regular "barrier strip" input for that signal should *not* be connected. Doing so will give unpredictable results, but will *not* damage the drive.

Field Customizing

Field Customizing the drive to use the analog input requires the person doing the customizing, or the "editor", to provide the drive with a few pieces of information. These are as follows:

- The analog signal "destination" routing
- The analog signal "source type"
- The minimum value desired
- The maximum value desired for our purposes, the terms "Minimum Value" and "Maximum Value" are described below:

Minimum Value:

"Minimum Value" refers to the number that will be obtained when the analog source is at its lowest point. For potentiometer sources, that means when the pot "wiper", (the part that moves with the pot shaft) is closest to the pot terminal that is connected to signal common (zero volts on the wiper). For voltage sources, that means zero volts measured between the analog input and signal common. For current sources, the minimum value is obtained with a current of 4mA or less.

Maximum Value:

"Maximum Value" refers to the number that will be obtained when the analog source is at its highest, or most-positive point. For potentiometer sources, that means when the pot "wiper" (the part that moves with the pot shaft) is closest to the pot terminal that is connected to the +5VDC barrier strip terminal on the drive(+5VDC on the wiper). For voltage sources, that means +5VDC measured between the analog input and signal common. For current sources, the maximum value is obtained with a current of 20mA or greater.

Setting Minimum and Maximum Values

It may help to think of the analog input on the drive as a “black box”. This box will send out an integer (whole) number somewhere between the “Minimum Value” and the “Maximum Value”, depending on the signal present at the analog input when it is “sampled”. What this number represents is determined by the destination routing you have selected; however, there is a catch: The analog input “black box” on the drive may not be able to send out every possible integer between the Minimum and Maximum values that you set. This is due to a phenomenon known as “quantizing”. This fancy word simply means that any time you measure something, the measurement can only be as accurate as the smallest “markings on your ruler”. For example, if you had a ruler that was marked only in inches, you could only accurately measure something to the nearest whole inch. Anything else would involve guesswork (which the drive is rather ill-equipped to handle!) So, in this case, any measurements made with that ruler would be quantized to whole inches. Now, taking this example one step further, imagine that this is a magic ruler; that is, the ruler can be stretched or squeezed to fit any distance. Only there is a problem: The magic ruler can change its length, but when you do this, instead of more “inch” markings appearing (or disappearing), the ones that are already on the ruler get closer or farther apart!!

So, if your ruler is 10 inches (“real inches”) long to start with, it will have ten “inch marks” on it, numbered from 1 to 10. Now let’s say you stretch your ruler to measure something that is 20 inches long. Fortunately, although we cannot “grow” more markings on our magic ruler, the ten markings that are there change their numbers so that they always show the “real” inches at that point. This means that when your ruler has been stretched from its original length of 10 inches to 20 inches, the markings will read “2, 4, 6,...20”. Remember, you will still only have ten markings on your ruler. Now how accurately can you measure something for sure? That’s right, we have changed the “quantizing” of our ruler from 1 inch to 2 inches per marking.

The analog input “black box” also has a limited number of “markings” on its “ruler”. This number is determined by two things: 1) The electronics of the analog input; and 2) The analog “source type” selected. For “potentiometer” and “voltage sources”, the number of “markings” or “steps” that the analog input has available is 1024. For “current source (4 to 20mA)” use, the number of steps is reduced some-what, to 810. That means if we are using a potentiometer to control the “target speed” of the drive, and you have set the “Minimum Value” to be 100 (engineering units), and the “Maximum Value” to be 1000 (engineering units), the closest you will be able to set the target speed to a desired value is equal to $1000 - 100 \div 1024 = 0.88$ (or about 1) of whatever your engineering units is. Values between these numbers simply “don’t exist”, as far as settings for the “target speed” is concerned.

Items Used by the Analog Input

NOTE: For a complete discussion on how to program the drive, please refer to the drive Operating manual section “Field Customizing the drive”.

On the next page is a table showing the various items involved with the analog input on the drive. Note that all of the items reside on Page 12. The text of this applications note should help in determining the proper value to set each item for a particular application.

Wiring Connection

Below is a drawing of the female RJ45 “modular “ connector in the drive, showing the pins that are used for

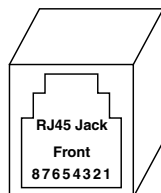

RJ45 Pin	Signal Description
6	Signal Common (Ground)
7	Analog Input (0 to +5VDC)

analog input. For the sake of clarity, the other pins on this connector are not described here. See the drive manual section “Communications and Networking” for descriptions of those pins.

You will need an eight conductor RJ45 male as well as eight conductor modular cable to use the analog input. A six position RJ12 connector may also be used as an alternative. Your local computer store or Radio Shack should have all of the supplies you need to fabricate this cable, or should be able to fabricate one for you. Depending on the type of signal you will be using, you may also have to use an external resistor, or an external potentiometer. Wiring for the various signal input configurations is shown below.

Wiring Diagrams for Each Source Type

Below are three diagrams showing the basic input wiring necessary for each type of analog input source. You should find these helpful in determining the proper wiring for your application.

WARNING:

The **Absolute Maximum** signal range that can be safely applied to the analog input is from **-0.5VDC to +20VDC**. Signals outside this range can result in permanent damage to the OPT51. This is *not* the maximum useful signal range, but rather the maximum overload capacity of the analog input. For proper operation, the **useful** signal range is from zero to +5VDC. Voltages that are outside of this range will be treated as the minimum and maximum values, respectively.

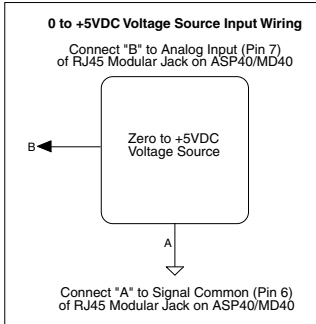

Mode: 0-5Vdc:

Parameter	Value	Description
120	2	Slot 500
5040	1	Target Speed
5041	2	0-5Vdc Input

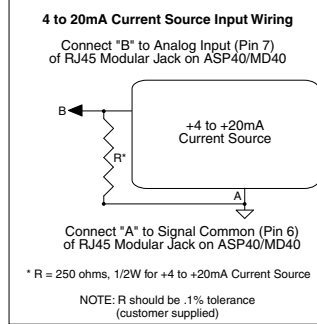

Mode: 4-20mA:

Parameter	Value	Description
120	2	Slot 500
5040	1	Target Speed
5041	3	4-20mA Input

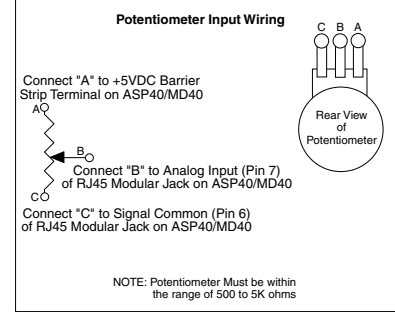

Mode: Potentiometer:

Parameter	Value	Description
120	2	Slot 500
5040	1	Target Speed
5041	1	Potentiometer Input

Note: All three of these Analog Inputs will retain their setting if the AC power would be cycled OFF/ON.

Using the Frequency Generator Output*

The OPT51 has a frequency generator output that can be used as the leader signal to drive a network of followers. The OPT51 that is generating this signal can even follow its own generator's output. This allows a ratio system to operate without a dedicated leader motor and pick-up. To follow this signal, connect pin 5 of the RJ45 connector to the spare input (P1-8) of the follower OPT51 controls. This signal may also drive the master input of other Dart controls such as the ASP10, ASP40, MD10P, and MD40P.

The frequency generator output is available on pin 5 of the RJ45 connector. The common for this signal is available either from pin 6 of the RJ45 connector or from the main terminal block P1-5. Use only one of these common terminals to make electrical connections between devices. The output is an Open-Collector NPN transistor which is capable of sinking a maximum of 500mA up to 100 volts DC. The frequency of this output is set using Item 5032-5034. The frequency is set in pulses-per-minute from 4 to 9999. To change this frequency using the front panel pushbuttons, Item 5032 must be set to the new value.

Example: Item 5032 set for a value of 7200. (7200/60 secs = 120 pulses/min)

The RJ45 connector pin out is as follows:

* NOTE: The Frequency Generator Output on the OPT51 can also be used as a "User Assignable Output" instead of a Frequency Generator Output. See the section "User Assignable Outputs" for details.

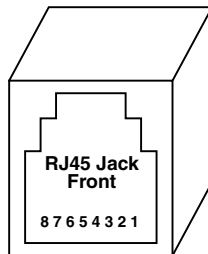

RJ45 Pin	Description for Frequency Generator Output
1	No Connect
2	No Connect
3	No Connect
4	No Connect
5	Frequency Generator Out (Do not use for RS232 Communications)
6	Circuit Common
7	No Connect
8	No Connect

WARNING: DO NOT connect the OPT51 directly to the phone system! Permanent damage to the control WILL result.

User-Assignable Output

The OPT51 incorporates an advanced “User-Assignable Output”. This feature allows an editor to customize the physical output circuit normally used as a Frequency Generator Output, for use as a general-purpose output capable of driving LEDs, small relays, solid-state alarm modules, and the like. This output is an Open-Collector NPN transistor which is capable of sinking a maximum of 500mA up to 100 volts DC. See the section “Using the Frequency Generator Output” for more information about proper wiring of the User-Assignable Output. The output can be “connected” to any combination of up to eleven different “conditions”, such as “Pickup Stalled”, “Actual Speed Outside Limits”, etc. by using its "Assignment Matrix" switches. See main control manual Alarm "Logic" section. Through the use of the "Inverter Matrix" switches, in main control manual Alarm "Logic" section, the opposite of any condition(s) can be used instead ("Pickup not Stalled", "Actual Speed Limit not Exceeded", etc.) for even more flexibility. Additionally, the output can be set to either "Normally Open" (N.O.) or "Normally Closed" (N.C.) operation with the "Output Selection" Switch, Item 5031. See the main control manual Item Descriptions section for details. This output arrangement provides the user with literally hundreds of possible combinations, while keeping the actual electronic complexity (and cost) of the control to a minimum.

There are two different ways that the "circuitry" of the User-Assignable Output can be expressed. For those familiar with digital logic symbols, please refer to the figure on the main control manual Alarm "Logic" section for a "circuit" description. If you are more familiar with "Ladder Logic" symbology, please refer to the bottom figure instead for a "schematic" representation. However, regardless of which method you are more comfortable with, it is important to remember a few things:

- This "circuitry" is actually implemented in software, not hardware, and although it actually makes little difference to the final output produced, that fact should be kept in mind.
- Often there is more than one way to "connect-up" the signals and inverters to achieve the desired result; but NOTE: Signal "polarity" is always a tricky problem in "logic circuits". Sometimes it takes a bit of careful planning to arrange "inverted" and "non-inverted" signals properly.

Communications and Networking

The OPT51 can be connected through its built-in RS232/422/485 serial port to a terminal, computer, process controller, other controls, or various other devices to greatly expand its ability to monitor, control and report in many ways. The best thing about the OPT51 is that it only requires an ordinary serial port, rather than special network hardware or “transporter” cards, to establish communications. A convenient “jumper block” in the OPT51 is used to select either RS232 or RS422/485 communications. This section discusses the hardware and software issues involved in communicating with the OPT51.

Commonly Used Software

When using a computer to configure the OPT51 series controls, a few things are needed. First, a computer with either an RS-232 or RS-485 communications port or an USB port must be located. The RS-232 or RS-485 port will be either a DB-9 or DB-25 male connector. Adapter cables and/or accessories may be needed. Dart has CBL1 and CBL2 available for this purpose.

Second, a software package that allows the computer to easily communicate with a selected com port must be obtained. Fortunately, there are a number of available packages that are capable of filling this need. For a Windows computer, a simple RS232 terminal program called “Termie” can be downloaded from the Internet at ‘www.termie.sourceforge.net’.

Regardless of the chosen software package, it will be necessary to configure the software appropriately to allow it to communicate with the OPT51 Serial Card. These products ship with their serial communications port set at 9600 baud, 8 data bits, and 1 stop bit. Setting the terminal program to half duplex—sometimes called local echo—will allow the user to see the text as they type. It is also very important that the flow-control setting be set to OFF.

Read the next several pages for more information on serial communications.

Hardware - Jumper Selection

RS232 - RS422/485 Jumper Selection

To choose between RS232 or RS422/485 communications, you must make sure the 232/485 “Jumper” (JP1) is in the correct position. The drawing showing the location of this jumper is on page 8.

Once you have found the jumper, move it like this:

RS422/485: Place the “jumper block” on pins 1 & 2 (Marked RS485)

RS232: Place the “jumper block” on pins 2 & 3 (Marked RS232)

Connect the cable to the RJ45 “Modular” Jack. Now that you have selected which communications standard you wish to use, see following pages to help you wire the Modular Cable properly for RS232 or RS422/485 operation.

RS232 and RS422/485 Connections to the RJ45 Modular Jack

The OPT51 RS232 and RS422/RS485 port uses a standard 8 pin RJ45 modular connector. A standard 4 or 6 pin RJ11 or RJ12 modular connector may also be used as an alternative when making RS422/485 connections. When using a RJ11 or RJ12 cable, that has 4 or 6 conductors, with the RJ45 Modular Jack on the OPT51, you are only connecting to the middle 4 or 6 pins of the RJ45 Modular Jack. A 4 pin modular connector uses the middle 4 pins, numbers 3 through 6 and the 6 pin modular connector uses the middle 6 pins, numbers 2 through 7. The use of an 8 pin RJ45 modular connector will be required when making connections for RS232.

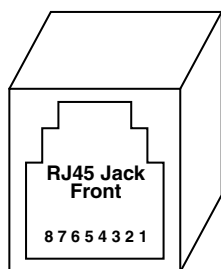

RJ45 Pin	RS232 & RS422/485 Signal Description
1	RS232 Receive Data (Data to Control)
2	No Connect
3	TxD+, RxD+ (+ transmit/receive data line)
4	TxD-, RxD- (- transmit/receive data line)
5	No Connect
6	Circuit Common, Signal Ground
7	No Connect
8	RS232 Transmit Data (Data from Control)

There is currently NO standard wiring format for a RJ45 Modular connector when used in RS232 or RS422/485 applications. We have chosen to allow the use of standard 4, 6, or 8 pin modular connector in our wiring scheme. The RJ45 Modular Jacks pinout for the OPT51 is as follows:

It is important to understand the minor differences between RS-232 and RS-422/485. Simply put, RS-232 is a point-to-point interface standard which is intended to allow two — — and only two — — devices to be attached to one another; whereas, RS-422 and RS-485 are multi-point interface standards supporting as many as 32 devices on the same lines or bus. Another key difference is that RS-422 and RS-485 are considerably more tolerant to noisy environments. With this in mind, it is typically not recommended that RS-232 be run more than 50 feet. Specialty converters can be purchased, however, for under a hundred dollars to allow an RS-232 device to interface with one or more units on a shared multi-point bus. Once the desired interface standard has been selected, jumper JP1 should be positioned accordingly. Failing to do so will not damage

the drive, but will result in a lack of communication.

When connecting a device with an RS-422 or RS-485 port to an OPT51 unit, the multi-point bus should be connected in half-duplex mode. In this mode, the four bus wires are connected in two pairs to the unit. Specifically, the Transmit+ and Receive+ are connected to the unit's RJ45 pin 3. The Transmit- and Receive- are connected to the unit's RJ45 pin 4. Under some circumstances, it may also be necessary to connect the unit's Signal Ground, RJ45 pin 6, to the remote device's Signal Ground. In this configuration, the RJ45 pins 1 and 8 should remain disconnected.

When connecting a computer with an RS-232 port to an OPT51 unit, not all of the available wires have to be used. If a port with a DB-9 (9 pins) connector is used, then the following connections should be made: DB9 pin 2 to RJ45 pin 8, DB9 pin 3 to RJ45 pin 1, and DB9 pin 5 to RJ45 pin 6. If a port with a DB-25 (25 pins) connector is used, then the following connections should be made: DB25 pin 2 to RJ45 pin 1, DB25 pin 3 to RJ45 pin 8, and DB25 pin 7 to RJ45 pin 6. In this configuration, the RJ45 pins 3 and 4 should remain disconnected.

When communicating with a computer, there are a number of pitfalls to overcome. Initially, it is important to make sure the terminal program is communicating with the correct port (ie: COM1, COM2, etc.). This can be difficult because the port numbers are not labeled on the back of most machines. Use the following outline when troubleshooting new connections:

- 1) Set the terminal program to 9600 baud, 8 data bits, no parity, 1 stop bit, and half duplex.
- 2) Set the terminal program to the selected serial port: COM1, COM2, etc. (guess if unknown)
- 3) If necessary, unplug the cable from the selected serial port on the back of the computer.
- 4) Regardless of DB-9 or DB-25, carefully short pins 2 and 3 together on the computer.
- 5) Enter the following string of characters in the terminal window: 123123
- 6) 112233112233 should be displayed in the terminal window. If 123123 was displayed instead, it is likely that the wrong serial port has been chosen. Go back to step 2.
- 7) Now that the correct port has been located on the computer, remove the short from pins 2 and 3.
- 8) Connect the cable to the back of the computer, but do not connect the other end to the MD Plus series control. Instead, temporarily short pins 1 and 8 of the RJ-45 plug on the cable.
- 9) Enter the following string of characters in the terminal window: 123123
- 10) 112233112233 should be displayed in the terminal window. If 123123 was displayed instead, it is likely that either the cable is bad or pins 1 and 8 are not shorted correctly. Go back to step 8 and test again.
- 11) At this point, the computer is configured and cable is probably wired correctly. Remove the temporary short and plug the cable into the drive's modular jack.
- 12) Type the following command into the terminal window (using all capital letters): AS01 (followed by pressing the computer's Enter key)
- 13) The unit should respond with the actual speed, then the connection is complete and functional; otherwise, it will be necessary to double-check the wiring and repeat some of the above tests.

NOTE: Many of the commercially available modular connectors cables you buy off the shelf will invert the wires going between the two connectors on the ends of the cable. Improperly wiring the serial ports will not damage the control or the communications peripheral but the communications will not work. In case of difficulty, Dart's Technical Support Department will be happy to help you, or ask your computer dealer for assistance.

WARNING: DO NOT connect the OPT51 directly to the phone system! Permanent damage to the control WILL result.

Software - Data Format

The OPT51 uses a standard serial interface protocol found on most, if not all, computers, process controllers, terminals, etc. The format for data is as follows:

Start Bits:	1
Data Bits:	8
Stop Bits:	1
Parity:	NONE
Duplex:	Half (No Echo)
Baud Rate:	Selectable (see below)

There are two items that are involved with communications. To avoid confusion, we suggest that you do not program these items through the serial port (although that is possible). The items are as follows:

Item 20: **Network Address.** This can be a value from 01 to 99. If you have more than one OPT51 on your network, you probably want to set each unit to a unique address. By the way, commands sent to address "00" will be acted upon by every OPT51 on your network. This can be quite helpful for example, to do an "All Stop" command.

Item 21: **Baud Rate.** This can be a value from 1 to 8. A table showing the baud rates for the possible values of this item is shown below:

Value	Baud Rate
1	300
2	1200
3	2400
4	4800
5	9600
6	19200
7	38400
8	57600

Obviously, all of the members of a network should have the same baud rate.

NOTE: Baud Rate changes take effect immediately.

Format for Messages

NOTE: First a word about the acceptable (to the OPT51) letters and numbers. The OPT51 has been designed to reject all but the following:

- The Numbers from 0 thru 9
- UPPERCASE ONLY letters from A thru Z
- The "comma" (,) character (used to separate different parts of a message)
- The "carriage return" character (used to end each message)

If invalid characters are used, it results in a failed command. In the case of numbers with a decimal point (or colon) in them, do not send the decimal point (or colon). Also, it is not necessary to send any "leading zeros" for a number. "0001", "001", "01", and "1" are all the same to the OPT51. Note: All addresses must be two digits so 01 through 09 must have a leading zero.

All messages sent to the OPT51 follow a common structure, or “format”. The command message format is shown below:

<command><address>,<“command stuff”><CR>

<command> A two-letter UPPERCASE command. There is NO comma between the command and the <address>

<address> A number (01 thru 99) representing the device that this message is intended for. Using an address of “00” will cause all devices to react to the message. This number is followed by a comma.

<“command stuff”> The portion of the command message that is unique to each command. See the details of the commands for this information. There is NO comma after the end of this portion of the message, although there may be commas within “command stuff”.

<CR> A “Carriage Return” character (ASCII 13 decimal {0D hexadecimal}). This means the end of this message. This is the character you get when you press “Return” or “Enter” on your computer keyboard. Some computers also send a “Linefeed” character (ASCII 10 decimal { 0A hex}). The OPT51 will ignore linefeeds sent to it, and it will not send linefeeds after <CR> on its outgoing messages.

example: “Set the speed of the OPT51 addressed as “01” to 1000”
format: **SP01,1000**

Remember, there is a “carriage return” character at the end of the message.

Direct Commands from a Computer/PLC

There are six commands implemented on the OPT51; however, these six commands will allow you to do quite a number of things (commands must be in upper case). These commands are discussed below and on the following page:

SP Set Target Speed (or Time in seconds)

Description: Allows the setting of a desired speed (or Process Time)

Format: **SP**<address>,<speed><CR>

<speed> is usually scaled in Engineering Units; however, in Follower modes, the "speed" setting is always expressed as a "percent of leader". Additionally, <speed> is expressed as seconds when in Time mode. The current program's "Setting Limits" determine the lowest and highest values you can use for <speed>.

Example: Set the speed of the OPT51 addressed as "03" to 500 ("whatevers")

Format: **SP03, 500**<CR>

Response if successful: **Y**<CR>

Response if unsuccessful: **N**<CR>

NOTE: The Set Target Speed commands are not stored in non-volatile memory, consequently upon power-up in Auto Mode, they will revert to zero. When power-up in Manual Mode, they will revert to previous number stored in NOV-RAM.

SV Set Variable

Description: Allows the setting of any item to any value within its range.

Format: **SV**<address>,<item>,<value><CR>

<item> and <value> are the same as if you were editing from the drive front panel. Reference control manual for "Item" and "Value" meanings.

Example: Set the OPT51 addressed as "06" to set Display Maximum to 1750

Format: **SV06, 21, 1750**<CR>

Response if successful: **Y**<CR>

Response if unsuccessful: **N**<CR>

NOTE: This command can actually be used to great advantage. For example, sending the message **SV00, 12, 1** to a network of controls with multiple programs, would effectively switch all controls on the network to that program at one time. The most obvious example of such a usage might be in a multiple-auger materials blender.

RV Read Variable

Description: Outputs the value of any item plus its decimal point location.

Format: **RV<address>,<item><CR>**
These are ONLY available through the Serial Port

Example: Read the OPT51 addressed as "02" for the value of Item 10.

Format: **RV02, 10<CR>**

Response if successful: **<value>,<dec. pt.><CR>**

Response if unsuccessful: **N<CR>**

NOTE: In the response from the OPT51, <value> and <dec. pt.> will ALWAYS be transmitted as 4 digits, with leading zeros present. <dec. pt.> is the location of the displayed decimal point for that variable. Its values are: xxxx. = 0, xxx.x = 1, xx.xx = 2, xxx = 4.

TS Get Target Speed

Description: This returns the target speed of the motor in the Engineering Units as defined by the drive.

Format: **TS<address><CR>**

Example: Read the OPT51 addressed as "02" for the actual speed of the pickup, in Engineering Units.

Format: **TS02<CR>**

Response if successful: **<value><CR>**

Response if unsuccessful: **N<CR>**

AS Get Actual Speed

Description: This returns the actual speed of the motor in RPM's.

Format: **AS<address><CR>**

Example: Read the OPT51 addressed as "07" for the actual speed of the pickup, in RPM.

Format: **AS07<CR>**

Response if successful: **<value><CR>**

Response if unsuccessful: **N<CR>**

AL Get Alarm State

Description: This returns the status of Alarms 1 and 2. The value is a binary number, please refer to Setting and Reading "Alarm" Conditions section of the drive manual.

Format: **AL<address><CR>**

Example: Read the OPT51 addressed as "10" for getting the Alarm Status.

Format: **AL10<CR>**

Response if successful: **<Alarm1 state>, <Alarm2 state><CR>** where the states are 0 for Off, 1 for On.

Response if unsuccessful: **N<CR>**

OPT51 Software Parameters (Items)

Note: Add the ModularBus “Slot” Number (100, 200, 500) X 10 to the Item number below to determine the actual Item Number in the Host Drive’s Item-Numbering scheme. For example, to set Item 41 of an OPT51 in ModularBus Slot 500, you would select Item 5041 (500 X 10 +41).

Item	Description	Value Range	Units	Factory Default	User Setting
Read-Only Identification Items					
1	Model Number	51 = Serial	—	51	
2	Software Version	1 – 9999	—	—	
3	Hardware Version	1 – 9999	—	—	
4	Device Type	100 = Type 1 Modular Bus Card	—	100	
5	Minimum Supported Framework Version	1 – 9999	—	—	
6	Reserved	0	—	—	
7	Serial Number (Major)	0-9999	—	—	
8	Serial Number (Minor)	0-9999	—	—	
Serial Setup					
20	Network Address	1 - 99	—	1	
21	Baud Rate	1 = 300 2 = 1200 3 = 2400 4 = 4800 5 = 9600 6 = 19200 7 = 38400 8 = 57600	—	5	
User-Assignable Output					
30	Output Function	0 = Off 1 = Frequency Generator – Analog IN 2 = Frequency Generator – Motor Speed 3 = Frequency Generator – Fixed (Item 32) 4 = Alarm Output	—	0	
31	Output Selector (N.O./N.C.)	0 = Normally Open (N.O.) 1 = Normally Closed (N.C.)	—	0	
32	Frequency Generator Output Frequency	0 - 3 4 - 9999	Disabled Pulses/Min	0	
33	Frequency Generator MIN	0 - 9999	Pulses/Min	0	
34	Frequency Generator MAX	4 - 9999	Pulses/Min	2400	
Analog Input					
40	Analog Input Destination Routing	0 = NONE (Analaog OFF) 1 = Target Speed 2 = Percent of Target 3 = RESERVED 4 = Freq. Gen. Rate 5 = Main Tach Signal 6 = Leader Tach Signal	Engr. Units Engr. Units NONE Pulses/Min. RPM RPM	0	
41	Analog Input Source Type	1 = Potentiometer 2 = 0 to +5 VDC Voltage 3 = 4 to 20mA Current	—	1	
42	Minimum NUMERIC Value Sent Out by Analog Input	0 – 9999	—	0	
43	Maximum NUMERIC Value Sent Out by Analog Input	0 - 9999	—	2400	

OPT51 Software Item (Parameter) Descriptions

Item 1 – Model Number (Read Only)

This number represents the base model number for the product. The model code for the OPT51 ModularBus card is, logically enough, 51. In this manual, where appropriate, the “Drive” in which this OPT51 card is installed is called, generically, the “Host Drive”.

Item 2 – Software Version (Read Only)

The software version is a code which identifies the software “build number” of the unit.

Item 3 – Hardware Version (Read Only)

The hardware version is a code which identifies which hardware was used to build the unit.

Item 4 – ModularBus Card Device Type (Read Only)

This value is primarily used to determine whether the particular ModularBus card has on-board non-volatile storage for its Item settings. The OPT51 is a “Type 1” ModularBus card (value = 100), which does not have its own non-volatile storage. It depends on the Host Drive to store its Item settings. This means that if an OPT51 must be replaced in a Host Drive, the “new” OPT51 does not need to be configured. It will simply “inherit” the “old” OPT51’s Item settings, provided it is placed in the same ModularBus Slot.

Item 5 – Minimum Supported Framework Version (Read Only)

The lowest software “framework” version that is compatible with this ModularBus card.

Item 6 – Reserved

Item 7 & 8 – Serial Number, Major & Minor (Read Only)

These Items are reserved for future use as an electronic serial number and are unique to each manufactured unit.

Item 20 – Network Address

Sets the address for network identification.

Item 21 – Baud Rate

Sets the Baud Rate used for all communications to this card.

Item 30 – Output Function

Sets the function of the User-assignable-output.

Mode 0: Off

This will cause the user-assignable output to be turned off and not used.

Mode 1: Frequency Generator – Analog Input

This will set the frequency out to be controlled by the analog input. Note: when selecting this mode, the Analog Input Destination must also be set to frequency generator rate.

Mode 2: Frequency Generator – Motor Speed

This will set the frequency out to be controlled by the motor speed.

Mode 3: Frequency Generator – Fixed (Item 32)

This sets the Frequency Generator with a fixed output, the value is in PPM. The rate can be changed by setting a value in Item 32.

Mode 4: Alarm Out

This will cause the output to be controlled by the Alarm 2 from the host drive. *Note: When using this function Item 81, Alarm 2 Output Routing, of the host drive must be set to Mode 4, Route Alarm 2 Output to ModularBus Slot 500. Also by selecting this mode an alarm output trigger will be sent out to the serial host device, but only for alarm 2 and not alarm 1 from the host drive.*

Item 31 – Output Selector (N.O / N.C.)

Determines whether User Assignable Output is Normally Open (0) or Normally Closed (1).

Item 32 – Frequency Generator Output Frequency

This sets the output frequency from the frequency generator.

Example: Set Item 32 to 7200 PPM and the square wave output frequency is 7200/60 equals 120Hz.

Item 33 – Frequency Generator Min.

This sets the lowest output frequency from the frequency generator. Note: if you are using mode 1 of Item 30 of the OPT51 then this Item is controlled by Item 42 of the OPT51.

Item 34 – Frequency Generator Max.

This sets the highest output frequency from the frequency generator. Note: if you are using mode 1 of Item 30 of the OPT51 then this Item is controlled by Item 43 of the OPT51.

Item 40 – Analog Input Destination Routing

This sets how the analog input is to be used in the host drive.

Mode 0: Off

This will cause the input to not be used.

Mode 1: Target Speed

This will allow the analog input to control the set speed of the host drive.

Mode 2: Percent of Target

This will control a percentage of the set speed of the host drive.

Mode 3: RESERVED

Mode 4: Frequency Generator Rate

This will control the frequency output of the frequency generator. Note: When using this mode Item 30 of the serial communications board must be set to a mode of 1.

Mode 5: Main Tach Signal

This can be used as a main tach signal from the host controlled motor instead of using a standard pickup on S1 of the host drive.

Mode 6: Leader Tach Signal

This can be used as a master tach signal instead of a standard pickup on S2 of the host drive.

Item 41 – Analog Input Source Type

This identifies what type of input signal is being used.

Mode 1: Potentiometer

Mode 2: 0 to +5 VDC (Voltage)

Mode 3: 4 to 20 mA (Current)

Item 42 – Minimum Numeric Value Sent Out by Analog Input

This sets the numeric value which will be created when the analog input is at its lowest voltage (or lowest current for 4-20 mA input source type). Note: if you are using mode 1 of Item 30 of the OPT51 then this controls the Frequency Min.

Item 43 – Maximum Numeric Value Sent Out by Analog Input

This sets the numeric value which will be created when the analog input is at its highest voltage (or highest current for 4-20 mA input source type). Note: if you are using mode 1 of Item 30 of the OPT51 then this controls the Frequency Max.

Specifications

Electrical

OPT420 Isolated Alarm Relay Output Rating.....	50VAC @ 1A
OPT51 Output Drive Capability.....	100VAC @ 0.5A

REPAIR PROCEDURE

In the event that a Product manufactured by Dart Controls Incorporated (DCI) is in need of repair service, it should be shipped, freight paid, to: Dart Controls, Inc., 5000 W. 106th Street, Zionsville, IN. 46077, ATTN: Repair Department. Please include Name, Shipping Address (no P.O. Box), Phone Number and if possible, e-mail address.

Those orders received from anyone without an existing account with DCI must specify if they will be paying COD or Credit Card (Master Card/Visa/American Express). This information is required before work will begin. If you have an account with Dart your order will be processed according to the terms listed on your account. Products with Serial Number date codes over 5 years old will automatically be deemed Beyond Economical Repair (BER). A new, equivalent device will be offered at a substantial discount.

Completed repairs are returned with a Repair Report that states the problem with the control and the possible cause. Repair orders are returned via UPS Ground unless other arrangements are made. If you have further questions regarding repair procedures, contact Dart Controls, Inc. at 317-873-5211.

YOUR MOTOR SPEED CONTROL SOLUTION PROVIDER

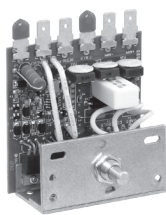

OEM Chassis SCR Drives
Dual Input voltage, adjustable HP range, isolated signal follower and reversing options

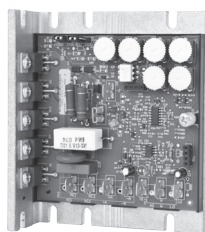

NEMA 4/4X SCR Drives
Dual Input voltage, adjustable HP range, isolated signal follower and reversing options

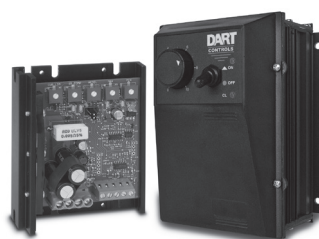

Low Voltage/Battery PWM Drives
Chassis and NEMA 4X versions, speed pot and signal follower operation



Digital SCR Drives
Closed loop accuracy, 4-20mA and serial communications, integral programmable display



Brushless DC Drives
Closed loop accuracy, line and low voltage versions through 1 HP



Digital Accessory & Resale Items

Motors to 700 HP, VFD's to 200 HP, NEMA rated encoder, digital programmable potentiometers and tachometers

Dart Controls, Inc. is a designer, manufacturer, and marketer of analog and digital electronic variable speed drives, controls, and accessories for AC, DC, and DC brushless motor applications.

Shown above is just a sampling of the expanded line of Dart controls that feature the latest in electronic technology and engineering. Products are manufactured in the U.S.A. at our Zionsville (Indianapolis, Indiana)

production and headquarters facility - with over 2,000,000 variable speed units in the field.

In addition to the standard off-the-shelf products, you can select from a wide variety of options to customize controls for your specific application. For further information and application assistance, contact your local Dart sales representative, stocking distributor, or Dart Controls, Inc.

Dart Controls, Inc.

Manufacturer of high quality DC and AC motor speed controls and accessories since 1963.

5000 W. 106th Street
Zionsville, Indiana 46077
Phone: (317) 873-5211
Fax: (317) 873-1105

www.dartcontrols.com
ISO9001 REGISTERED
MADE IN USA