

700B CONTROL SERIES

DART

CONTROLS

Instruction Manual

Low Voltage DC Brushless Control

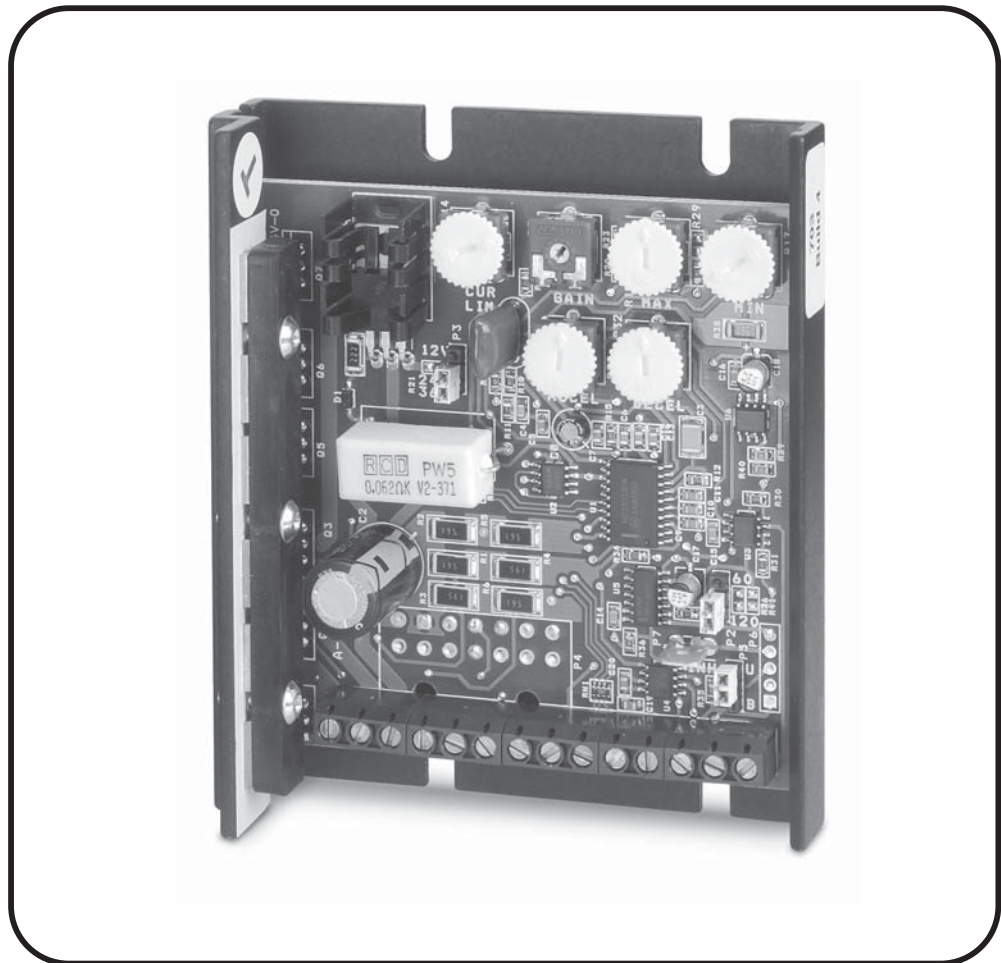

**P.O. Box 10
5000 W. 106th Street
Zionsville, Indiana 46077**

**Phone (317) 873-5211
Fax (317) 873-1105
www.dartcontrols.com**

TABLE OF CONTENTS

WARRANTY	2
WARNING	2
INTRODUCTION	3
CONTROL FEATURES.....	3
700B SERIES DIMENSION DIAGRAM	3
MOUNTING INSTRUCTIONS	4
MODEL SELECTION.....	4
BRUSHLESS MOTOR CONTROL HOOK-UP & FUSING	4
SENSOR SPACING & INPUT VOLTAGE SELECTION	4
MOTOR DIRECTION SELECTION AND REVERSING	5
HOOK-UP DIAGRAM.....	6
STANDARD HOOK-UP WIRING DIAGRAM.....	6
-PA OPTION HOOK-UP WIRING DIAGRAM.....	6
HOOK-UP PROCEDURE FOR MOTORS	6
WITH TIMING DIAGRAMS.....	6
HOOK-UP PROCEDURE FOR MOTORS	7
WITHOUT TIMING DIAGRAMS	7
OPEN LOOP (700BDC) TRIMPOT ADJUSTMENTS	7
CLOSED LOOP (701BDC and 703BDC) TRIMPOT ADJUSTMENTS	8
CLOSED LOOP (703BDC) TRIMPOT ADJUSTMENTS.....	8
HEATSINK & COOLING	9
SPECIFICATIONS.....	9
TIMING DIAGRAM FOR 60° MOTOR.....	10
TIMING DIAGRAM FOR 120° MOTOR.....	11

WARRANTY

Dart Controls, Inc. (DCI) warrants its products to be free from defects in material and workmanship. The exclusive remedy for this warranty is DCI factory replacement of any part or parts of such product which shall within 12 months after delivery to the purchaser be returned to DCI factory with all transportation charges prepaid and which DCI determines to its satisfaction to be defective. This warranty shall not extend to defects in assembly by other than DCI or to any article which has been repaired or altered by other than DCI or to any article which DCI determines has been subjected to improper use. DCI assumes no responsibility for the design characteristics of any unit or its operation in any circuit or assembly. This warranty is in lieu of all other warranties, express or implied; all other liabilities or obligations on the part of DCI, including consequential damages, are hereby expressly excluded.

NOTE: Carefully check the control for shipping damage. Report any damage to the carrier immediately. Do not attempt to operate the drive if visible damage is evident to either the circuit or to the electronic components.

All information contained in this manual is intended to be correct, however information and data in this manual are subject to change without notice. DCI makes no warranty of any kind with regard to this information or data. Further, DCI is not responsible for any omissions or errors or consequential damage caused by the user of the product. DCI reserves the right to make manufacturing changes which may not be included in this manual.

WARNING

Improper installation or operation of this control may cause injury to personnel or control failure. The control must be installed in accordance with local, state, and national safety codes. Make certain that the power supply is disconnected before attempting to service or remove any components!!! If the power disconnect point is out of sight, lock it in disconnected position and tag to prevent unexpected application of power. Only a qualified electrician or service personnel should perform any electrical troubleshooting or maintenance. At no time should circuit continuity be checked by shorting terminals with a screwdriver or other metal device.

INTRODUCTION

Dart Controls 700B Series is a family of general purpose brushless motor controls. These controls commutate power into standard 3 phase brushless (BLDC) motors.

The series uses DC power sources of 11 to 14VDC or 18 to 40VDC, including batteries of 12, 24, and 36 volts, selectable via the P3 jumper. The 700B Series will supply up to 5 amperes of continuous current to the motor. It is available in either a basic open loop (700BDC), a basic closed loop (701BDC), and a full featured closed loop (703BDC), and all can drive motors with sensor spacings of 60 or 120 degrees, selectable via the P2 jumper.

A 14 position terminal strip connects the control to the DC power source, the motor, the speedpot, and the forward/reverse control switch. There is a ¼" spade pin that can be used for inhibiting the control. The control's PC board carries the minimum speed, maximum speed and current limit trimpots for the 700BDC, an additional gain trimpot for the 701BDC, as well as accel and decel trimpots for the 703BDC. The 703BDC model also has a selectable jumper pin as a means for selecting a speedpot input operating modes of unidirectional or bidirectional center off (wigwag) mode.

CONTROL FEATURES

- **AVAILABLE IN OPEN LOOP (700BDC), CLOSED LOOP (701BDC) AND FULL FEATURED (703BDC) VERSIONS**
- **POWER MOSFET TRANSISTORS**
- **QUIET 15KHz "PULSE WIDTH MODULATED" SWITCHED FREQUENCY**
- **FORWARD/REVERSE DIRECTIONAL CONTROL**
- **5KΩ SPEED POTENTIOMETER W/ DIAL, LEADS & KNOB FOR REMOTE MOUNTING**
- **ANODIZED CHASSIS**
- **INHIBIT INPUT PIN FOR START/STOP OPERATION**
- **INTERNAL +6.2 VOLT DC SUPPLY FOR MOTOR HALL EFFECT SENSORS**
- **UNIDIRECTIONAL OR BIDIRECTIONAL WIGWAG MODE (703BDC MODEL ONLY)**

700B SERIES DIMENSION DIAGRAM

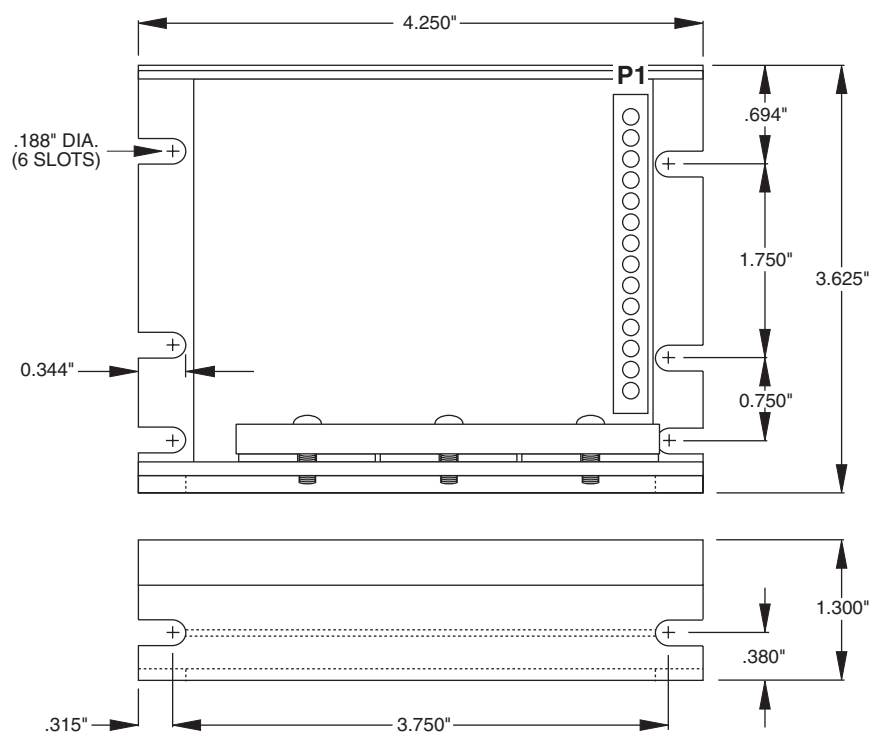

MOUNTING INSTRUCTIONS

1. Six 3/16" wide slots are provided for control mounting (see dimension diagram on page 2).
2. Control chassis can be used as a template.
3. Use standard hardware to mount.

Caution:

Do not mount where ambient temperature is outside range of -10° C (15° F) to 45° C (115° F).

MODEL SELECTION

MODEL #	CONTROL TYPE	INPUT VOLTAGE	PHASE
700BDC	OPEN LOOP	12VDC or 18-40VDC SELECTALBE VIA JUMPER	60° or 120° SELECTABLE VIA JUMPER
701BDC	CLOSED LOOP	12VDC or 18-40VDC SELECTALBE VIA JUMPER	60° or 120° SELECTABLE VIA JUMPER
703BDC	CLOSED LOOP	12VDC or 18-40VDC SELECTALBE VIA JUMPER	60° or 120° SELECTABLE VIA JUMPER

BRUSHLESS MOTOR CONTROL HOOK-UP & FUSING

Brushless DC motors have eight (8) wires: three (3) phase lines to the motor, three (3) Hall sensor lines, and sensor power and common. Also BLDC motors come in two sensor configurations, 60 and 120 degrees.

Many BLDC motor manufacturers are familiar with the 700B Series, and supply specific hook-up information for the Dart control. Other manufacturers only supply timing diagrams, leaving it up to the installer to generate a hook-up procedure. Finally, some manufacturers may supply motors with no accompanying information. The last two situations will be discussed later. All BLDC motors, no matter what the hook-up status, are connected to the 700B Series control as shown in figure 1 of the Hook-Up Diagram section.

Notice how the power is connected to terminals P1-4 and P1-5 through an appropriate switch and fuse. Dart recommends the use of a normal blow 5 ampere 3AG fuse. The power should be off until the hook-up procedure is complete and you are ready to run.

SENSOR SPACING & INPUT VOLTAGE SELECTION

Normally the 700B Series control is shipped ready for 120 degree sensor spacing (P2-2 and P2-1 connected). However, if you are connecting to a motor that has 60 degree sensor spacing, you will need to use the supplied jumper to connect P2-2 to P2-3. Note figure 1 of the Hook-Up Diagram section, which shows the location of the selectable sensor spacing connector and attached jumper connector. Using this selectable jumper connector enables the control to drive motors with 60 or 120 degree sensor spacings.

The input voltage is also jumper selectable and is shipped with the standard setting of 24/36VDC input (P3-2 and P3-3 connected). If 12 volt input is desired, move the supplied jumper to connect P3-2 to P3-1. See figure 1 of the Hook-Up Diagram section for location of the selectable input voltage connector and attached jumper connector.

SPEED COMMAND SELECTION AND HOOK-UP

700BDC 701BDC and 703BDC SPEED COMMAND HOOKUP

The 700B series controls can be operated with a 5K potentiometer (supplied with control) or a 0 to 5VDC power source. The 5K ohm speedpot is connected to terminals P1-12, P1-13, and P1-14. Connect the speedpot “LO” lead (orange wire) to terminal P1-14, the speedpot “WIPER” lead (red wire) to P1-13, and the speedpot “HI” lead (white wire) to P1-12. If you are not using a speed potentiometer to regulate speed, a 0 to 5V DC signal can be used. This is accomplished by connecting the DC source signal lead to terminal P1-13 (WIPER) and the common lead to terminal P1-14 (LO).

Note: A 5K ohm resistor must be connected from the Pot Hi terminal (P1-12) to the Pot Lo terminal (P1-14) for proper operation of the Min trimpot.

INHIBITING THE CONTROL MOTOR DIRECTION SELECTION

The 700B series control has a ¼” spade pin (P7) on the control that can be used to inhibit the control. Tying this pin to the control common terminal (P1-6) will stop the control and override any other speed command. Using inhibit to start and stop the control will over ride the accel and decel settings of the 703BDC model. For a start and stop function with accel and decel, it is recommended you open and close the pot wiper or signal wire, via a switch, to the control wiper input terminal (P1-13).

SELECTABLE SPEED COMMAND MODE

(703BDC ONLY)

Unidirectional Mode – Selectable via the P5 jumper with the jumper placed across the center position and the position mark “U”. This is a single direction operation mode with a zero to full adjustment of the speedpot or input signal giving you zero to maximum output voltage. In this mode the motor direction must be selected via the F/R (P1-8) terminal. (See **MOTOR DIRECTION SELECTION and REVERSING**)

Bidirectional Mode - Selectable via the P5 jumper with the jumper placed across the center position and the position mark “B”. This is a bidirectional (wigwag) operating mode that sets the center of the speedpot or input signal as the off position. A CW rotation of the speedpot or increased input signal will give you forward motor rotation and a CCW rotation of the speedpot or decreased input signal will give you reverse motor rotation. When using the bidirectional mode, the F/R (P1-8) terminal must be left unconnected..

MOTOR DIRECTION SELECTION AND REVERSING

Terminal P1-8 on the 700B Series is the forward/reverse control. Allowing terminal P1-8 to remain unconnected will let the motor turn in a particular direction. Connecting terminal P1-8 to P1-6 will reverse the rotation direction. You can use either a jumper wire, switch, relay, or an open collector NPN transistor to make this connection. **MAKE SURE WHEN YOU REVERSE DIRECTION THE MOTOR IS STOPPED. THE CONTROL ISN'T DESIGNED FOR PLUG REVERSING.**

Sometimes it may be necessary to reverse your motor without using terminal P1-8. This is done by stopping the motor and exchanging terminals P1-1 with P1-2 and terminals P1-10 with P1-11. This will work with either a 60 or 120 degree motor.

If your motor draws an excessive amount of current in reverse, you may have a motor designed for only one direction. Consult with the motor manufacturer about this problem.

This completes a general hook-up for the 700B Series. The next task is to connect the motor to the control. We think it's prudent that when first testing your motor a DC ammeter be placed in the DC power line. Zero to ten amperes is fine.

HOOK-UP DIAGRAM

STANDARD HOOK-UP WIRING DIAGRAM

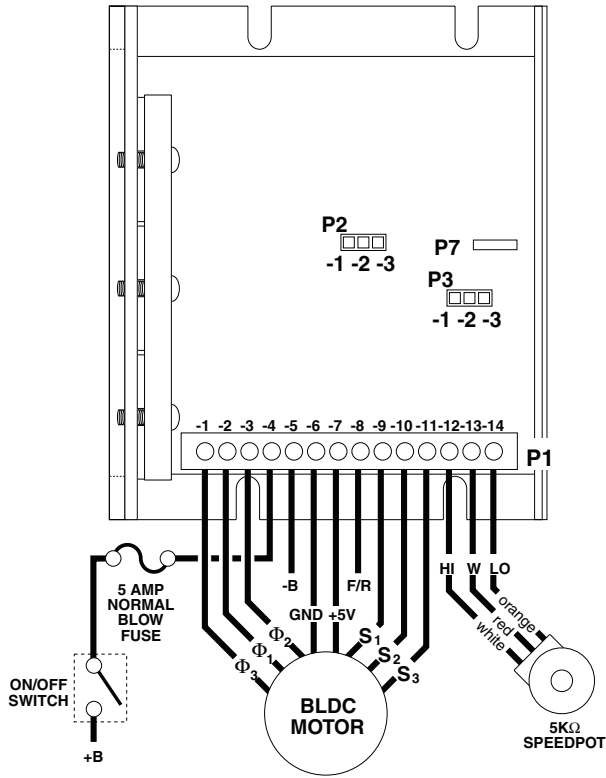
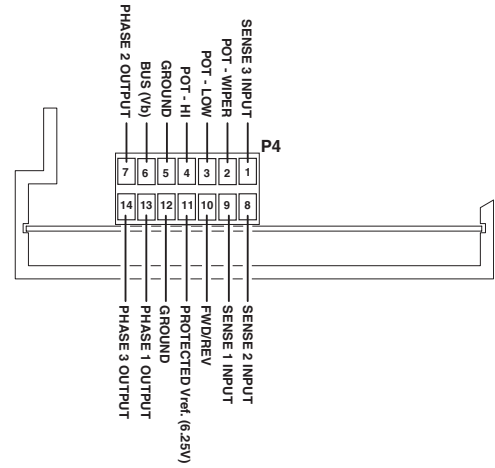

Figure 1

-PA OPTION HOOK-UP WIRING DIAGRAM



P4 Details:
 -14 Position, Tyco part number 1-770973-1
Customer supplied male end:
 - You can choose either the Positive Lock part (Tyco # 770582-1) or the Latch Lock part (Tyco # 794202-1)

Figure 2

HOOK-UP PROCEDURE FOR MOTORS WITH TIMING DIAGRAMS

Most manufacturers of BLDC motors send timing charts with their product. These diagrams describe the function of each motor line. They show sensor and phase line signals to the motor. Sensor diagrams are very helpful, but many times the relationship between phase and sensor diagrams can lead to confusion. Our procedure is to hook up the sensors according to their diagrams, then test for proper phase. Current limit will protect the control from miswired phases.

First determine the spacing of the motor Hall sensors. They will either be 60 or 120 degrees. Usually the motor manufacturer will tell you the spacing. If they don't, compare the sensor diagram sent with the motor with those in Figure 3 or 4. Observe that a 60 degree spacing will at some position have all sensor lines at a logic high. With 120 degree spacing, all three sensors are never at the same logic level at the same time.

Once sensor spacing is determined, return to the section "SENSOR SPACING & INPUT VOLTAGE SELECTION", and select correct phase and input voltage as stated in the procedure. With the control set up for the correct sensor spacing and input voltage (also see Fusing on page 3), return to Figure 1 or Figure 2 and connect the sensors to terminals P1-9 through P1-11. Notice that for the 60 degree spacing there is a specific sensor line that leads the sequence, followed by a line lagging by 60 degrees, and a third line lagging the second by 60 degrees. It is important that the middle line in the train be connected to terminal P1-10.

(continued)

After the sensors are connected, attach the 5 volt supply line to terminal P1-7. The sensor common line is connected to terminal P1-6. Now proceed to attach the three phase lines and test for proper hook-up.

We recommend arbitrarily attaching the phase lines to terminals P1-1, P1-2, and P1-3. Choose a configuration, test it, then keep track on paper of what you did.

Now apply power to the control. Slowly turn the speedpot CW. Observe for erratic rotation or currents over 1 ampere. If any of these conditions occur, immediately return the speedpot fully CCW, and turn off the power. Try a new phase line configuration, apply power and test again. There are six (6) different combinations for hooking the three phase lines to the control. One of them will work. Rotation will be smooth and the DC current will lie well below 1 ampere. You have now found the correct hook-up for your motor.

HOOK-UP PROCEDURE FOR MOTORS WITHOUT TIMING DIAGRAMS

If you have a BLDC motor with no timing diagram, it is possible, with a little patience, to sort out the various leads and operate it with the 700B Series control. Find a voltmeter that will read a 5 volt logic level.

First sort out the three phase leads from the sensors. Phase leads are usually a heavier gauge wire. Once you find the phase wires, check them by measuring the resistance between any two. The resistance should be low, a few ohms, and be the same across any two of the three leads.

The remaining five leads are the three sensors, sensor power, and common. To find the power and common, look for color and gauge differences. If all else fails, call the motor manufacturer. Once sensor power leads have been located, the remaining three leads will be the Hall sensors. Now construct a timing diagram using the sensor lines. First, connect the motor to the control, but leave off the three phase leads. Don't worry about sensor spacing at this time. Next connect your voltmeter to any sensor lead. Reference the meter to terminal P1-6. Apply power and slowly rotate the motor shaft by hand. You should see the meter move from 0 to 5 volts as the Hall sensor switches. Check the other two sensors for switching.

Next observe each sensor against the other and draw a timing diagram. You can now hook up the motor with this new information using the procedure for motors with timing diagrams.

OPEN LOOP (700BDC) TRIMPOT ADJUSTMENTS

CURRENT LIMIT - Dart has factory set the Current Limit to 14 Amperes peak (5 Amp DC average). You should not have to change this setting. You can set the current limit to a lower value by turning the Current Limit trimpot CCW. If you wish to use Current Limit to set the maximum *peak* current, then you may do so by looking with an oscilloscope at the voltage across the 0.062ohm 5W power resistor (R13). A .62 volt reading across this resistor is equivalent to 10 Amperes of current. If you wish to use Current Limit to set the maximum *average* current, then measure the average DC voltage drop across the 0.062ohm 5W power resistor and divide it by 0.062. This will give you your average DC current.

You can also monitor average motor current by placing a DC ammeter in series with the DC source, however this is only accurate when running full speed. The Current Limit trimpot is designed to be used for overload protection only. Do not use Current Limit trimpot to limit speed or torque.

Caution: Remember, keep the average current at 5 Amps or under, and make sure the motor is rotating. A stalled motor, after about 30 seconds, may overheat and cause extensive damage to the control and/or motor.

MINIMUM SPEED - Turn the speedpot to zero (fully CCW). Next turn the minimum trimpot CW until the motor begins to rotate. Slowly rotate the trimpot CCW until the motor stops. The control will now run with a zero deadband. If a nonzero minimum speed is desired, rotate the trimpot CW to the desired setting.

MAXIMUM SPEED - Turn the speedpot fully CW and adjust the Maximum adjust trimpot to the desired maximum output.

CLOSED LOOP (701BDC and 703BDC) TRIMPOT ADJUSTMENTS

1. Adjust the Maximum speed trimpot (MAX) to 50% CW rotation.
2. Set Closed Loop Gain trimpot to the fully CW position.
3. Advance your speedpot to the fully CW position. The motor should now be rotating at its maximum speed*.
4. Slowly rotate the Closed Loop Gain trimpot CCW until the motor speed decreases slightly**, then rotate the trimpot back CW just enough to return the motor to full speed.
5. Refer to the Open Loop Trimpot section above for Minimum Speed (MIN) and Current Limit (CUR LIM) trimpot adjustments.

* If your motor doesn't reach its maximum speed with the speedpot and the gain pot fully CW, rotate the MAX trimpot CW until it does. Proceed with step 4.

** If you rotate the Closed Loop Gain trimpot fully CCW and the motor speed doesn't decrease, rotate the MAX trimpot CCW just enough to make the speed decrease slightly. Then rotate the Closed Loop Gain trimpot CW just enough to return the motor to full speed.

CLOSED LOOP (703BDC) TRIMPOT ADJUSTMENTS

ACCEL - The Accel trimpot is adjustable from 0-10 second of maximum output speed setting. The setting of the accel time is approximately proportional to the rotation of the accel trimpot. As an example, a 50% setting of the accel trimpot will result in approximately a 5 second linear accel ramp from zero to maximum speed. To test a setting, turn the speedpot to zero (fully CCW). Next turn the accel trimpot CW to the estimated accel setting. Quickly rotate the speedpot full CW and time your motor accel ramp from zero to maximum speed. If necessary, adjust your accel trimpot setting as needed and test again.

DECEL - The Decel trimpot is adjustable from 0-10 second of maximum output speed setting. The setting of the decel time is approximately proportional to the rotation of the decel trimpot. As an example, a 50% setting of the decel trimpot will result in approximately a 5 second linear decel ramp from maximum to zero speed. To test a setting, turn the speedpot to maximum (fully CW). Next turn the decel trimpot CW to the estimated decel setting. Quickly rotate the speedpot full CCW and time your motor decel ramp from maximum to zero speed. If necessary, adjust your decel trimpot setting as needed and test again.

Note: Minimum, Maximum and Gain trimpot settings must already be completed to properly set and test Accel and Decel. Refer to the Open Loop and closed Loop Trimpot sections above for Minimum Speed (MIN), Maximum speed (MAX), Current Limit (CUR LIM) and Gain trimpot adjustments.

HEATSINK & COOLING

We recommend not letting the heatsink temperature rise above 75° C. (167° F.). The control, as shipped from the factory, will normally handle up to 5 amps continuous current. If the ambient temperature increases above 25° C. (77° F.), you must add more heatsink or decrease the current to keep the sink temperature from exceeding 75° C. Finally, no matter what the heatsink temperature, never exceed 5 amperes.

SPECIFICATIONS

INPUT VOLTAGE (JUMPER SELECTABLE)	11 to 14VDC OR 18 to 40VDC
OUTPUT VOLTAGE	0 to INPUT VOLTAGE
MOTOR HALL SPACING - ELECTRICAL (JUMPER SELECTABLE)	60° OR 120°
LOAD CURRENT (CONTINUOUS)	5 AMPS
SPEED RANGE	50 : 1
MINIMUM SPEED TRIMPOT	ADJUSTABLE 0-30% OF MAX.
CURRENT LIMIT TRIMPOT	ADJUSTABLE
OPEN LOOP SPEED REGULATION	(MODEL 700BDC) NONE
INPUT / OUTPUT CONNECTIONS	14 POSITION TERMINAL BLOCK
SPEED COMMAND SIGNAL	5Kohm SPEED POTENTIOMETER or 0 to +5V DC SIGNAL
OPERATING TEMPERATURE	0° C. to 45° C. (32° F. to 113° F.)
CLOSED LOOP SPEED REGULATION	(MODEL 701BDC and 703BDC) ± 1/2% OF BASE SPEED
MAXIMUM SPEED TRIMPOT	ADJUSTABLE 60 to 100% OF INPUT VOLTAGE
ACCELERATION / DECELERATION	(MODEL 700BDC and 701BDC) FAST START
.....	(703BDC) AJUSTIBLE 0 – 10 SECONDS
INTERNAL VOLTAGE SUPPLY (FOR MOTOR HALL SPACINGS)	+6.2 VDC

TIMING DIAGRAM FOR 60° MOTOR

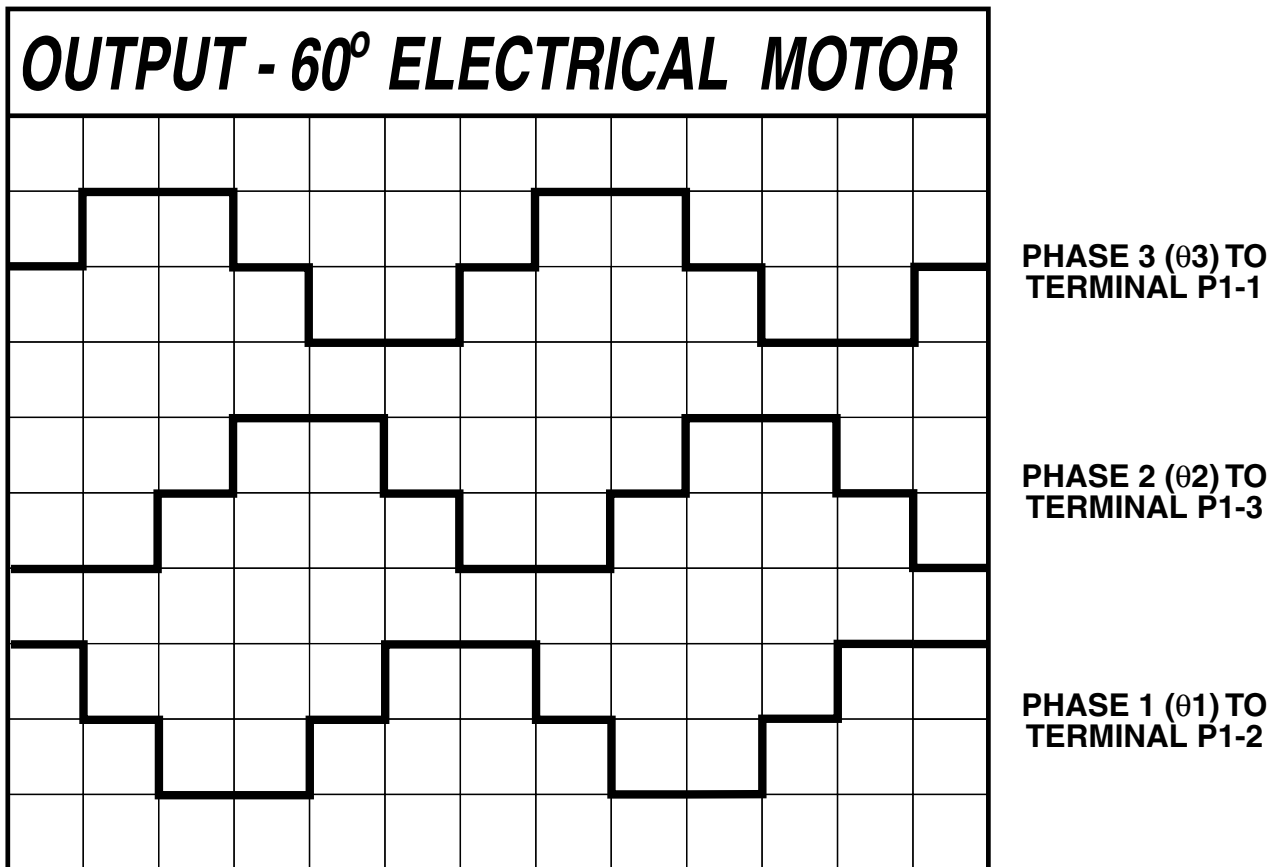
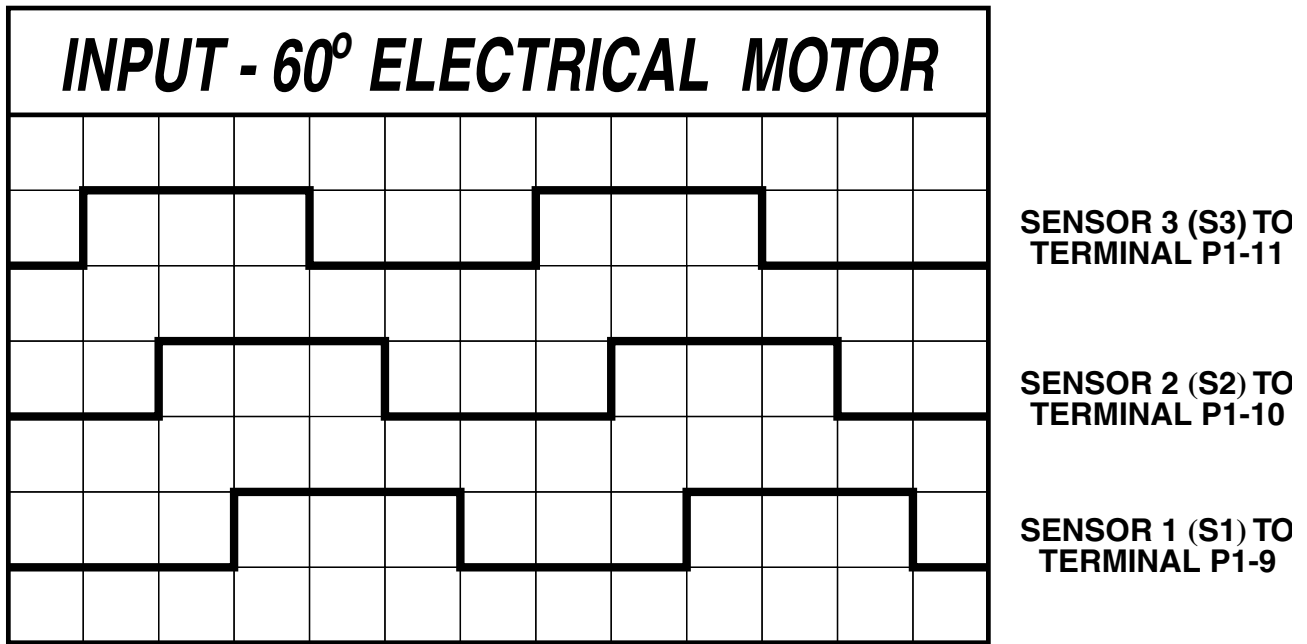

Figure 3

TIMING DIAGRAM FOR 120° MOTOR

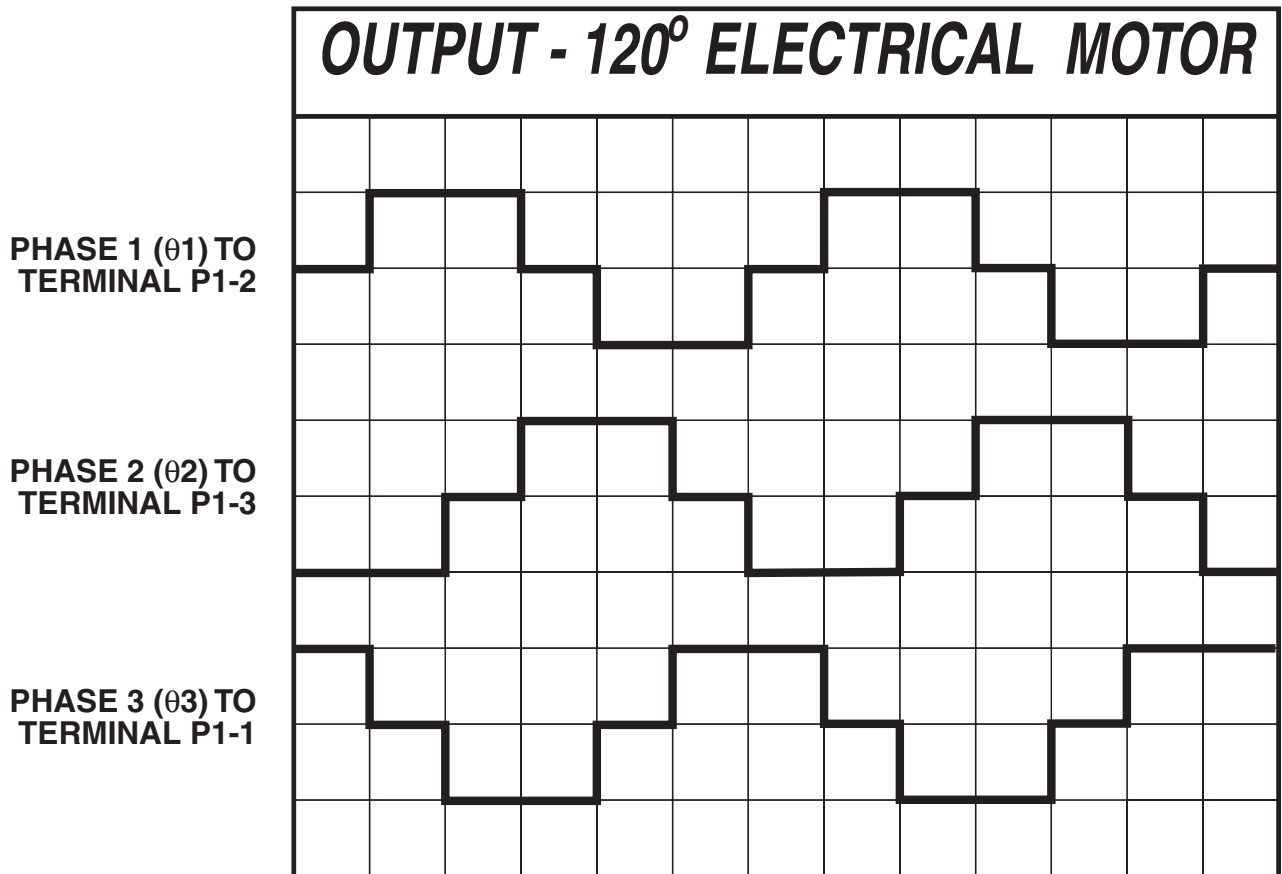
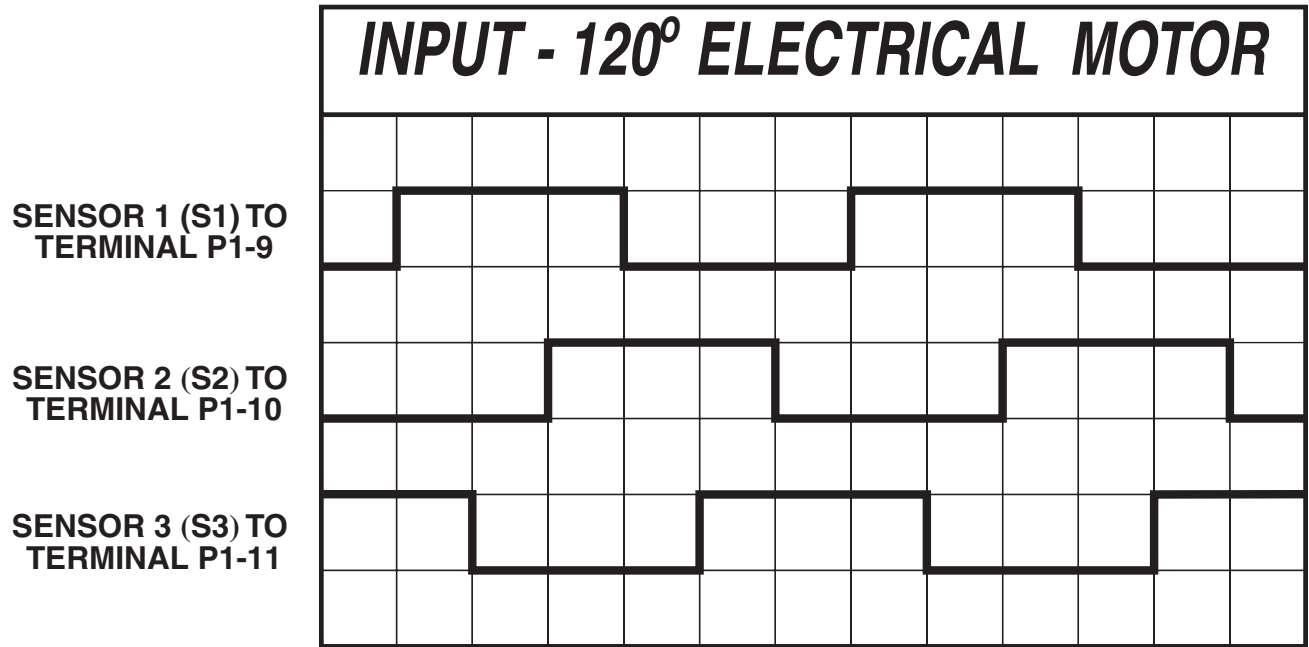

Figure 4

REPAIR PROCEDURE

In the event that a Product manufactured by Dart Controls Incorporated (DCI) is in need of repair service, it should be shipped, freight paid, to: Dart Controls, Inc., 5000 W. 106th Street, Zionsville, IN. 46077, ATTN: Repair Department. Please include Name, Shipping Address (no P.O. Box), Phone Number and if possible, e-mail address.

Those orders received from anyone without an existing account with DCI must specify if they will be paying COD or Credit Card (Master Card/Visa/American Express). This information is required before work will begin. If you have an account with Dart your order will be processed according to the terms listed on your account. Products with Serial Number date codes over 5 years old will automatically be deemed Beyond Economical Repair (BER). A new, equivalent device will be offered at a substantial discount.

Completed repairs are returned with a Repair Report that states the problem with the control and the possible cause. Repair orders are returned via UPS Ground unless other arrangements are made. If you have further questions regarding repair procedures, contact Dart Controls, Inc. at 317-873-5211.

YOUR MOTOR SPEED CONTROL SOLUTIONS PROVIDER



125D SERIES
AC INPUT - VARIABLE DC OUTPUT
1/50 HP through 1.0 HP



250G SERIES
AC INPUT - VARIABLE DC OUTPUT
1/50 HP through 2.0 HP



65 SERIES
DC INPUT - VARIABLE DC OUTPUT
CURRENT RATINGS OF 20, 40, AND
60 AMPS



700/COMMUTROL SERIES
DC BRUSHLESS
5 & 20 Amp for
12,24,& 36VDC Inputs



MDP SERIES
PROGRAMMABLE
CLOSED LOOP DC
SPEED CONTROL



DM SERIES
FIELD PROGRAMMABLE
DIGITAL TACHOMETER

Dart Controls, Inc. is a designer, manufacturer, and marketer of analog and digital electronic variable speed drives, controls, and accessories for AC, DC, and DC brushless motor applications.

Shown above is just a sampling of the expanded line of Dart controls that feature the latest in electronic technology and engineering. Products are manufactured in the U.S.A. at our Zionsville (Indianapolis,

Indiana) production and headquarters facility - with over 2,000,000 variable speed units in the field.

In addition to the standard off-the-shelf products, you can select from a wide variety of options to customize controls for your specific application. For further information and application assistance, contact your local Dart sales representative, stocking distributor, or Dart Controls, Inc.

Dart Controls, Inc.

Manufacturer of high quality DC and AC motor speed controls and accessories since 1963.

P.O. Box 10
5000 W. 106th Street
Zionsville, Indiana 46077
Phone: (317) 873-5211
Fax: (317) 873-1105